

Battery Guide 2022



BOSCH

Invented for life

THE eBIKE BATTERY GUIDE

Bosch eBike Systems | EN

[bosch-ebike.com](https://www.bosch-ebike.com)

Contents

PowerPacks and PowerTubes are the energy sources for Bosch eBike systems. Useful tips to determine and optimize range, efficiency and service life are provided on the following pages, as well as pointers for safety and handling.

- 4 — Bosch batteries and chargers
- 12 — Range
- 20 — Handling, care and transport
- 28 — Replace or repair?
- 30 — Recycling
- 32 — Safety
- 34 — Questions & Answers
- 35 — Test bench measurement R200



Lithium-ion batteries

Everything you need to know about eBike batteries



Areas of application

Lithium-ion batteries are used in smartphones, cordless screwdrivers and electric cars, as well as eBikes.



How it works

A lithium-ion battery generates electromotive force by displacing lithium ions. While the eBike is in motion, the electrodes move from the negative anode via the drive unit to the positive cathode. The lithium ions provide balance. The reverse process takes place when the battery is charged.

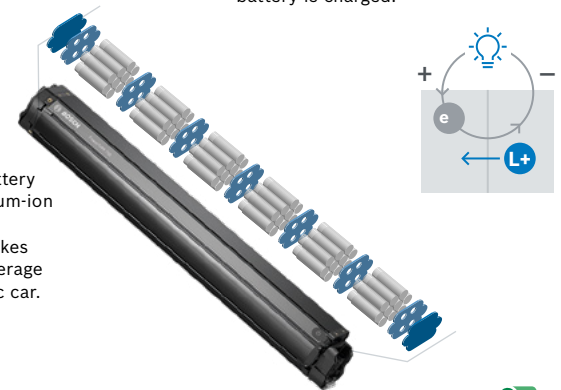

Engineering

A common eBike battery contains 40-60 lithium-ion cells. In terms of cell volume, 130 eBikes correspond to an average of about one electric car.



Costs

The cost of filling the tank of a passenger car is approximately \$38.28; the full charge of an eBike battery costs only 6 cents*. Thus, 638 eBike battery charges cost as much as filling the tank once.

Service life

In its service life, an eBike battery can take you an equivalent distance up to 1 1/2 times around the world.



Recycling

Some dealers will accept used eBike batteries and recycle them free of charge. Depending on the recycling process for a specific region, more than 80% of the precious raw materials can be recovered and recycled.



* All totals rounded to nearest cent. U.S. estimated national average gasoline price: \$3.19/Gal. U.S. estimated average cost of energy: \$0.11/kWh. Average sedan fuel tank size: 12 gallons. Thus, it only costs 6 cents to charge a battery with 500 Wh. Sources: ADAC battery test; Federal Environment Agency; Lithium-ion battery handbook; U.S. Dept. of Energy; EIA.gov

BOSCH BATTERIES AND CHARGERS

More energy for traveling

Bosch batteries provide the energy source for eBikes. They combine impressive range, a long service life and low weight at approximately 5.5 to 9.7 lbs. (2.5 to 4.4 kg.), with ergonomic design and convenient handling. The high-quality lithium-ion batteries are equipped with a Battery Management System (BMS). It continuously monitors the battery, detects potential sources of error and protects the cells as much as possible from overload.



Benefits

Reasons to choose Bosch eBike batteries

Efficient, durable, state-of-the-art technology: There are good reasons why Bosch eBike batteries are some of the most popular on the market.

▶ No memory effect

Bosch batteries with lithium-ion cells can be charged quickly and at any time irrespective of their charge level. Interruptions of the charging process do not harm the battery. Complete discharge is not required.

▶ Low self-discharge

Even after long periods of storage, e.g. during winter months, the battery can be used without recharging. For longer storage, a charge status of approximately 30-60% is recommended as is charging after a longer period in storage.

▶ Long service life

Bosch batteries are designed for lots of trips, miles and years of service. The intelligent, electronic Bosch Battery Management System (BMS) continuously protects against excessive operating temperatures, overloading and deep discharge. The BMS checks every cell, extending the life of the battery.

▶ Rapid charging

Bosch chargers are available in a range of different sizes and performance levels, and enable rapid charging according to your needs.

▶ Easy to remove

Bosch batteries can be removed with a few simple hand movements. The battery can therefore be charged and stored away from the eBike. This simplifies use, for example, when using in the winter. As the battery delivers less power at lower temperatures, in winter it should be stored at room temperature until shortly before a ride.

▶ Extremely efficient

Bosch batteries represent an economical drive solution. It costs no more than 6 cents to fully charge a PowerPack 500 (based on a green electricity rate of 11 cents per kWh).

▶ Competent service

Bosch batteries are well-protected and require little maintenance. Should support be required, a competent service team is available to provide assistance.

▶ Safety matters

Our complete eBike system is certified to UL 2849 safety standard and meets all rigorous requirements of this safety standard for peace of mind.

Bosch batteries

Powerful in every design



Frame battery

PowerPack Frame

Sporty and dynamic: When used as a frame battery, the PowerPack 400 or 500 sits close to the center of gravity of the bike to ensure optimal weight distribution.



PowerPack 400
PowerPack 500



PowerPack 400
PowerPack 500



Rack battery

PowerPack Rack

Comfortably convenient: On step-through models, the rack battery frees up space and allows the rider to mount and dismount safely. Available in two variants: 400 or 500.



Integrated battery

PowerTube

Stylishly elegant: There are two versions of the PowerTube: horizontal or vertical. Both are installed by the manufacturer according to the eBike's specific design. They are available in 400, 500 or 625 versions. There is a PowerTube with 750 Wh for the smart system.



PowerTube 400
PowerTube 500
PowerTube 625
PowerTube 750*



2 x PowerPack
2 x PowerTube
PowerPack + PowerTube



DualBattery

DualBattery

Double the power: Combining two Bosch eBike batteries provides energy content up to 1,250 Wh.**

* Only available with components of the smart system.

** DualBattery is not available in combination with PowerTube 400.

*** Advertised battery capacity is an approximation. Due to many different factors, the measured capacity of the battery may vary slightly from the advertised battery capacity.

Bosch chargers

Reliable power sources

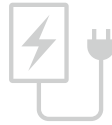

Bosch chargers are handy, lightweight and robust. Wherever your journey may take you: The 2 A Compact Charger, the 4 A Standard Charger, and the 4A Charger for the smart system, supply Bosch eBikes with power quickly and reliably. All Bosch chargers work quietly and are suitable for all battery types. They also feature a practical velcro fastener for easily stowing the cable.



Compact Charger

Faithful companion: The Compact Charger is ideal for all cyclists who are constantly on the move. It weighs less than 600 g and is 40% smaller than the Standard Charger—small enough to fit into many saddlebags.



Standard Charger

All-rounder: The robust and functional Standard Charger features a unique balance between performance, size and weight. It is suitable for every possible use.



4A Charger

Compact: As a small and lightweight charger, the 4A Charger is ideal when you are on the go. It charges the PowerTube 750* in a short period of time.

* Only available with components of the smart system.



Charging times

As fast as you like



Charging times depend on the capacities of the batteries and the type of charger. The graphics below show how quickly various batteries can be charged with a particular charger.



Bosch battery	PowerPack 400 PowerTube 400	PowerPack 500 PowerTube 500	PowerTube 625
Compact Charger	 approx. 6.5 h approx. 2.5 h	 approx. 7.5 h approx. 3.5 h	 approx. 8.8 h approx. 4.2 h
Standard Charger	 approx. 3.5 h approx. 1.5 h	 approx. 4.5 h approx. 2 h	 approx. 4.9 h approx. 2.1 h

■ 50% charge ■ 100% charge

Bosch battery	DualBattery 1250*	PowerTube 750**
4A Charger (smart system)	 approx. 17.6 h approx. 8.4 h	 approx. 6 h approx. 2.3 h
4A Charger (smart system)	 approx. 9.8 h approx. 4.2 h	

The smart system

* DualBattery is not available in combination with PowerTube 400.

** Only available with components of the smart system.

RANGE

What is the range of a single battery charge?

This is a common question for many riders. There is a vast number of factors that have an effect on the range. Sometimes a single battery charge will take you less than 12 miles (20 km), while at other times it will take you much farther than 62 miles (100 km). Following a few tips can help maximize the range of the battery.



The Bosch Range Calculator

Easier planning

The range of Bosch batteries depends on numerous factors. Range is influenced by the rider and the chosen support mode, as well as the drive unit or battery installed in the eBike. Environmental factors such as temperature, wind conditions and riding surface also play a key role in how far you can get on a battery charge.

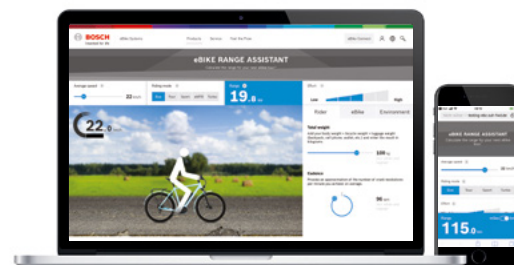

Our **range calculator** tool makes it possible to estimate typical range under various parameters. This online tool will show important information regarding battery range in a visual, easy-to-understand way.

Calculate the range for yourself:





bosch-ebike.com/range



Product line ranges

Extending your range

The range graphs show how far the product lines can travel with different batteries under favorable conditions (average value of all support levels). The range will be reduced in difficult conditions.

	 Favorable conditions*	 Difficult conditions*
 Rider		
Cadence	50–70 rpm	70–90 rpm
Total weight (Overall weight consisting of rider including eBike and cargo)	231 lbs. (105 kg.) 330 lbs. (150 kg.) for Cargo Line	253 lbs. (115 kg.) 375 lbs. (170 kg.) for Cargo Line
Rider type/ rider performance	Average	Average
 eBike		
Bosch eBike system	Drive Unit, battery and Intuvia	Drive Unit, battery and Intuvia
Shifting system	Derailleur system	Derailleur system
Tire tread	City bike tires	MTB tires
Bicycle type	City	MTB
 Environment		
Terrain type	Hilly	Low mountain ranges
Surface	Mainly gravel and paved forest paths	Dirt tracks and off-road trails (e.g. trail biking)
Starting frequency	Bike ride with occasional standing starts	Bike ride with regular standing starts
Wind conditions	Slight wind	Moderate wind

* The ranges are typical values of new rechargeable batteries, which may vary if one of the conditions listed above changes.

Range of the various Bosch batteries in mixed modes*

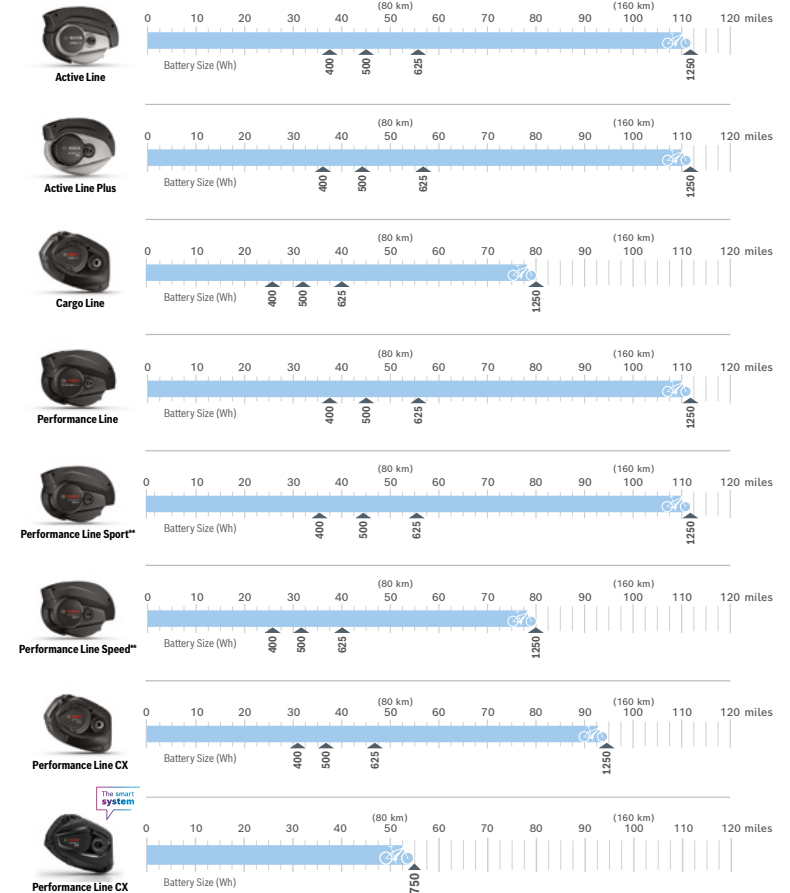

* Average of combined use of all modes and favorable conditions.

** These drive units are not available in Canada.

Range and riding modes

How they relate

The range of the Bosch eBike system is largely dependent on the level of support. A choice of different riding modes is available. The graphic shows their effect on the range in favorable (light blue) and difficult (dark blue) conditions.

Range based on the example of the Active Line with PowerPack 500 or PowerTube 500 taking account different riding modes.

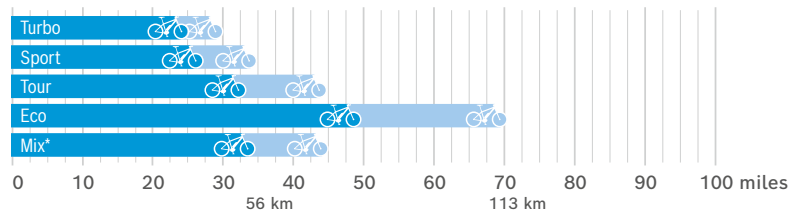







Difficult conditions* Favorable conditions*

For a definition of conditions, see p. 14.

* The ranges are typical values of the new rechargeable batteries, which may vary if one of the conditions listed above changes.

Overview of riding modes

-  **Eco** Efficient support for maximum range
-  **Tour** Consistent support for longer rides
-  **Tour+** Continuous support for energy-saving rides
-  **Sport** Powerful support for all types of riding
-  **eMTB**** Dynamic support for a natural feel
-  **Turbo** Maximum support for challenging rides

*Contact your local dealer to find out whether your eBike can be updated with Tour+ mode.

**The eMTB mode replaces the Sport mode on eBikes with the Performance Line and the Performance Line CX drive units.



Tips & tricks

To maximize range

► Cadence

Cadences above 50 revolutions per minute optimize the efficiency of the drive unit. Very slow pedaling, especially in high gears, on the other hand, costs the battery more energy.

► Weight

Weight should be minimized by keeping the total weight of the bicycle and cargo from being unnecessarily high.

► Starting & braking

As with a car, frequent starting and stopping is less economical than long distances at almost constant speed.

► Shifting system

Correct gear shifting also makes eBiking more efficient. It is best to start off and tackle inclines in a low gear, then shift to a higher gear in accordance with the terrain and speed. The computer provides shift recommendations.*

► Tire pressure

Rolling resistance can be minimized with the right tire pressure. Tip: To maximize the range, inflate the tires to the maximum permissible pressure.

► Motor performance indicator

Use the motor performance indicator on the Intuvia, Kiox and Nyon computers to monitor the motor and adapt your riding style accordingly. A longer bar indicates higher power consumption.

► Battery & temperature

With decreasing ambient temperature, the performance and range of a battery is temporarily reduced, as the electrical resistance increases. Therefore, in cold temperatures, a temporary decrease in the usual range is to be expected.

* Except Purion, SmartphoneHub, and Kiox 300.



HANDLING, CARE AND TRANSPORT

High-tech can still be simple

Batteries are highly complex components and some simple rules and instructions should be followed for handling, caring for and transporting them. This makes it easy to handle batteries and also has a positive effect on their service life.

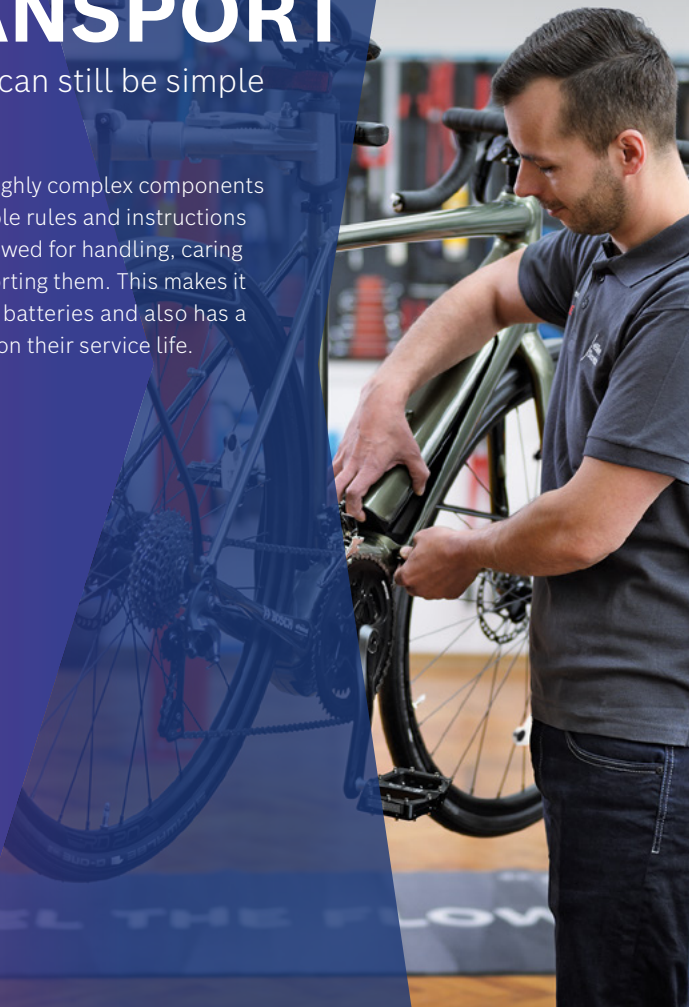

Charging

At home and on the road

Charging on the eBike

PowerPacks and PowerTubes are easy to charge directly on the eBike itself. Simply insert the plug on the charger into the socket in the battery mount and insert the power plug into the wall outlet. The batteries should be charged at room temperature in a dry location where a smoke detector is installed.

Charging a removed battery

If the battery cannot be charged directly on the eBike, the PowerPack and PowerTube can be easily removed.



Removal and installation

A few simple steps

Bosch batteries are seated securely in their mounts, even when riding over rough terrain. They can, however, be easily removed for storage or charging purposes: Simply open the lock and remove the battery from the mount.

Bosch batteries also can be reinserted just as easily and intuitively. Their low weight, handy dimensions and the precise fit of battery and mount make this possible. The battery engages positively in its holder and thus sits firmly in the frame or on the eBike.

► PowerPacks

All PowerPacks are equipped with an ergonomic handle, which enables the battery to be conveniently inserted, removed, carried and charged.

► PowerTube

A convenient function means that the PowerTube moves approximately .78 in (2 cm) out of the frame when unlocked, making it easier to handle. In addition, a safety mechanism prevents the battery from falling out of its mount. The battery is also protected by the frame.



Removing the battery



Open the frame cover, if applicable.



When the battery is unlocked using a key (depending on the manufacturer), it automatically drops into the restraint support.



Push the top of the battery to detach it from the restraint support. The battery then lowers into your hand.



Remove the battery from the frame.

Inserting the battery

The battery is inserted by following steps 1 to 5 in the reverse order. Depending on the manufacturer, the key must be turned (5) to insert the battery. Finally, the battery must be checked for a secure fit.



Care

How to increase the service life of the battery

The Bosch battery is an important component of the eBike. With the correct handling and care, its service life can be lengthened.

Cleaning & care

A damp cloth is recommended for cleaning the battery. Plug connections should be cleaned occasionally and lightly greased. The battery should be removed before cleaning the eBike. To protect the electronic components, the battery must never be cleaned with a direct jet of water or high pressure hose.

Storage during winter

Store the battery in a dry location at room temperature. Fully charging or fully discharging results in higher loading of the battery. The ideal charge status for lengthy periods of storage is approximately 30-60% or two to three LEDs on the battery indicator.

Winter use

During winter use, particularly below 32°F (0°C), charge and store the battery at room temperature and insert it in the eBike immediately before a ride. For longer journeys in cold conditions, use thermal protective covers.



Service life

Tips for maximizing your charge

The service life of Bosch batteries is influenced mainly by the type and duration of use. Like every lithium-ion battery, a Bosch battery also ages over time, even if you do not use it. Over time, it loses capacity.



Factors that shorten the service life:

- ▶ Heavy-duty use
- ▶ Storage at more than 86°F (30°C) ambient temperature
- ▶ Prolonged storage in below 32°F (0°C) charged or fully discharged state
- ▶ Exposure to direct sunlight
- ▶ Regular complete discharge of the battery



Factors that extend the service life:

- ▶ Low load
- ▶ Storage at temperatures between 32°F (0°C) and 68°F (20°C)
- ▶ Storage at approximately 30-60% charge status
- ▶ Storage in a shaded or cool location

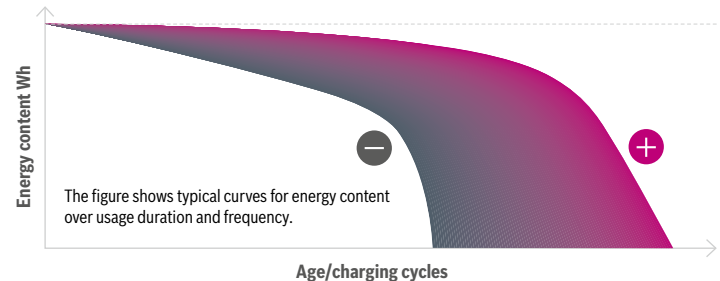

Transport

Safety while on the go

Lithium-ion batteries store large amounts of energy. That's why some precautions are necessary during transport. Ideally, the battery should be set to approx. 30% discharged and only fully charged again at the destination.



By car

If the eBike is being transported with a bike rack, remove the battery first and place it in a safe location inside the car.



By plane

The International Air Transport Association has forbidden the transportation of eBike batteries on passenger planes. Renting a Bosch eBike battery at your destination is recommended. Check in advance whether the airline will transport eBikes without a battery.



By train

In trains with bicycle compartments, most eBikes may be transported without any hassle. eBikes often need an extra ticket and a reservation. The eBike battery must remain permanently installed during the journey and must not be charged. Contact the respective service provider for precise information on the transport conditions. In some cases, it is not possible to take eBikes on all routes.



On commuter services and long-distance buses

On commuter services—light rail services, for example—it is often permissible to take a bike on board at regional off-peak times, provided you have purchased a bicycle ticket. It is advisable to obtain information from the relevant transport authority before traveling. The policies for transporting pedelecs on long-distance buses varies from company to company. In this case, you should also inquire in good time before starting your journey.



A eBike battery is a hazardous item. **When shipping,** the special regulations of the hazardous goods law apply. It is therefore practically impossible for private individuals to ship a battery.

REPLACE OR REPAIR?

When the battery starts to run down

eBike batteries are wearing parts and all lithium-ion batteries lose capacity over time. For safety reasons, faulty, old or “worn-out” batteries should not be repaired or refreshed, but should be recycled in the appropriate manner.

Risks attached to repairing or refreshing Bosch eBike batteries

Lithium-ion batteries are complex, finely tuned systems with a high energy content. In the case of repair or “refreshing,” i.e. when replacing originally installed cells with supposedly identical individual cells as part of a repair, correct function and optimum interaction with the Battery Management System can no longer be guaranteed. There is a risk that the Bosch eBike battery pack, once opened, will catch fire due to a short circuit as a result of improper repair. After it is broken, the seal of the housing can no longer be guaranteed. Ingress of water or dust can damage the monitoring electronics or the cells themselves. Here, too, there is a risk that the Bosch eBike battery could catch fire due to short circuiting. These dangers also exist at a later point in time if an eBike battery, once opened, is used again.

In addition, there is a safety risk, and opening or modifying the battery may void any warranty or guarantee claims. Furthermore, approval for transport and safety of the battery, which has been carefully developed and tested as a type according to international regulations, will be rendered void.

For safety reasons, batteries must pass an elaborate series of tests in which the test specimens are pushed to their load limits. Only then may the batteries be brought to market. These series tests are not feasible for an individual repaired battery due to the number of test samples required. All of this can have safety-relevant consequences.



For safety reasons, Bosch strongly advises against having batteries repaired. In such cases, it is necessary to replace the entire product.

RECYCLING

Sustainable use of raw materials

The CO₂ footprint of an eBike is largely determined by the production, use and recycling of the battery. The longer an eBike is used and the more trips by other means of transport it replaces, the better for the environment. To ensure that valuable raw materials can be reused at the end of their lifetime, the battery must be properly recycled.



Recycling

Once a battery has reached the end of its lifetime, it must be disposed of appropriately. Bosch urges eBike users to take defective or disused batteries to their local dealer, who can ensure they are disposed in the appropriate manner. Appropriate recycling practices save resources, and valuable raw materials are returned to the materials cycle.

Responsibilities

Responsibility for recycling lies with the battery manufacturer. As soon as the eBike crosses a national border, however, the importer (in countries outside of Germany, this means the bicycle manufacturer or bicycle retailer) automatically becomes the manufacturer. Because of this, Bosch eBike Systems can only provide a direct solution for battery recycling in Germany. We support eBike manufacturers in the other countries as best we can.

Recycling efficiency

Bosch eBike Systems supports new and sustainable recycling methods. The efficiency of recovery depends on the recycling process. In the recycling processes used by the German GRS industry solution, many valuable raw materials are recovered to more than 80% and can be reused for new products. As a result, these recycling processes are considered to be very environmentally friendly.

Second use

Our batteries are specially designed and certified for use with eBikes. We cannot guarantee reliable operation in other application areas.

More on sustainability:

bosch-ebike.com/sustainability



SAFETY

Safe handling of batteries

Bosch batteries are lithium-ion cells, which are developed and manufactured to the state of the art. In their charged state, these batteries have a high energy content. The constituents of lithium-ion cells are flammable under certain conditions. The operating manual contains instructions on safe handling.

► Double the protection

Each individual cell in a Bosch battery is protected by a rugged steel cup and held in a plastic or aluminium housing. This housing must not be opened. Direct impact, major shocks, dropping and excessive heat (including unnecessary direct sunlight) must also be avoided at all costs, as this could damage the battery cells and cause flammable contents to leak.

► Safe charging

In conjunction with the Battery Management System integrated within the battery, Bosch chargers protect the battery against overload during charging, as well as damage caused by extreme overcharging and short circuits. Bosch batteries are to be charged exclusively with authentic Bosch chargers because

these are designed exclusively for eBikes with Bosch drives and the components ensure a perfectly coordinated charging and discharging process. Batteries must only be charged in a dry state and must not be charged in the vicinity of heat sources or flammable materials. We recommend storage in dry, well-ventilated and uninhabited rooms with smoke detectors that are not designated for use in escape routes. After charging, batteries and chargers should be disconnected from the power supply.

► Storage

Excessive heat and direct sunlight must be avoided. Bosch batteries and chargers must not be stored in the vicinity of heat sources or flammable materials. We recommend removing the battery from the eBike for storage purposes and keeping it in well-ventilated rooms fitted with smoke detectors. Dry locations with an ambient temperature of approximately 68°F (20°C) are the most suitable. Bosch batteries must not be stored at below 50°F (10°C) or above 104°F (40°C).

► Inspection

Using the Bosch DiagnosticTool, the bicycle dealer can check the status of the eBike, especially the battery, and determine the number of completed charging cycles. The CapacityTester can also be used to determine the current energy content of the battery.

► Cleaning

Cleaning with a damp cloth is recommended. To protect the electronic components, the batteries must never be cleaned with a direct jet of water or high pressure hose.



► Disposal

Used batteries must be disposed of properly at the end of their service life. Some bicycle dealers will accept the return of used or defective batteries free of charge and take care of their proper disposal. eBike batteries do not belong in the household waste or in ordinary battery collection containers.



Bosch eBike batteries must never be opened, not even if they are being repaired. Opening the battery always means interfering with its certified condition and entails safety risks. Further important information about safety risks and risks from battery repairs can be found on Pages 28 and 29.

QUESTIONS & ANSWERS

Everything you need to know about batteries

► What should I do if water gets into the battery mount?

The mount is designed in such a way that water can drain off and the contacts can dry. To ensure that this happens, the mount and plug area should be kept clean. The contacts are supplied with a coating which protects the surface against corrosion and wear. Terminal greases or technical Vaseline may also be used to maintain the contacts if required.

► What happens to defective batteries?

Heavily damaged batteries should not be touched with bare hands as electrolyte may leak out, causing skin irritation. Damaged batteries are best stored in a safe place outdoors with the connection contacts taped over before being taken to the dealer for disposal.

► Can I use replacement batteries from other manufacturers?

Original Bosch spare parts are the only way to guarantee your safety. Bosch eBike Systems components are precisely matched and certified as a complete system. They offer the highest level of reliability and efficiency.

► Are chargers from other manufacturers safe to use?

Bosch chargers are adapted specifically to the Bosch eBike system and have the correct software for charging and managing Bosch batteries optimally. Using a different charger may reduce the service life of the battery or cause other damage or malfunctions in the eBike system.

► I have found a used battery for the Bosch eBike system online. Can I use it?

When purchasing used batteries, always make sure that they have not been damaged by their previous owner. Damaged or repaired batteries are offered online from time to time, but these may pose a possible high safety risk and can lead to dangerous malfunctions. Sometimes illegal, e.g. stolen goods, also are sold online. If applicable, ownership of such goods cannot be acquired legally in accordance with § 935 BGB [Bürgerliches Gesetzbuch, German civil code].

TEST BENCH MEASUREMENT R200

Making battery performance comparable

In order to be able to measure the range of eBikes in a standardized way for comparison purposes, Bosch eBike Systems, working in cooperation with ZIV (Germany's bicycle industry association) and other companies from the bicycle industry, has developed a standardized range test, R200. This will enable manufacturers, dealers and customers to compare the range of different eBikes on an objective basis.



The same conditions for transparent values

Previous test results for eBike range depended heavily on the rider and the external conditions (total weight, tires, air pressure, surface, weather, etc.). The R200 measurement method compares eBike performance with a uniform support factor of 200% (hence the name, R200). This means that the tested drive system supports an average rider performance of 70 watts with 140 watts, which corresponds to a medium-to-high-support factor.

R200 provides practical comparison

The result of the test is a specific indication of how many miles an eBike will cover under these standard conditions. Manufacturers need, however, to test each model individually using the R200 method. The operator simply enters the values from the list of requirements.



4054289006686

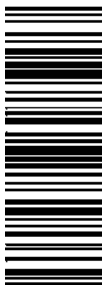

Robert Bosch LLC

Bosch eBike Systems
27211 Burbank
Foothill Ranch, CA 92610
USA

Connect with us:



[bosch-ebike.com](https://www.bosch-ebike.com)



[/BoscheBikes](https://www.facebook.com/BoscheBikes)



[/boschebikesystems.us](https://www.instagram.com/boschebikesystems.us)



[/BoscheBikeUS](https://www.twitter.com/BoscheBikeUS)