

# Nyon

## Online Version (BUI350)



en Original operating instructions





# Table of Contents

Safety instructions .....	6
Safety information relating to the navigation system.....	7
Privacy notice.....	8
Congratulations .....	9
Product description and specifications .....	9
Intended use .....	9
Product Features .....	11
Technical data .....	12
Declaration of Conformity .....	13
Fitting.....	14
Inserting and removing the on-board computer (see figures <b>A–B</b> ) .....	16
Operation .....	17
Starting up the eBike system.....	17
Requirements .....	17
Switching the eBike system on/off .....	17
Standby Mode .....	18
Power supply of the on-board computer .....	18
Battery Charge Indicator .....	19
Initial operation of the on-board computer .....	20
Creating a User ID.....	20
Connecting the On-board Computer with the Portal.....	21
Connecting to the On-Board Computer using the Bosch eBike Connect App.....	21
Setting the assistance level.....	22
Switching the push assistance on/off .....	23
Switching bicycle lights on/off.....	23
Lock (premium function) .....	23
Compatibility.....	24
Setting up the Lock function .....	24
How it works.....	25
Replacing eBike Components and the Lock Function .....	26

<b>Activity tracking</b> .....	26
eShift (optional) .....	27
ABS – anti-lock braking system (optional).....	27
Software Updates .....	27
Notes on cycling with the eBike system .....	27
Taking care of your eBike.....	27
The Nyon operating system.....	28
Premium features.....	29
User Administration.....	29
Displays and configurations of the on-board computer.....	31
<b>&lt;Status Screen&gt;</b> .....	32
<b>&lt;Settings&gt;</b> .....	33
<b>&lt;Ride Screen&gt;</b> .....	35
<b>&lt;Trip Data&gt;</b> .....	37
<b>&lt;Map Screen&gt;</b> .....	38
Active Navigation .....	42
<b>&lt;AutoZoom 2D&gt;</b> .....	43
<b>&lt;Rerouting&gt;</b> .....	43
Range Display .....	43
<b>&lt;Trip Analysis&gt;</b> .....	44
<b>&lt;Savings&gt;</b> .....	44
Creating Your Own Screens .....	45
<b>&lt;Fitness&gt;</b> (preset screen) .....	46
Determine destinations .....	47
<b>&lt;eMTB&gt;</b> (preset screen).....	47
<b>&lt;Basic&gt;</b> (preset screen) .....	48
<b>&lt;Quick Menu&gt;</b> .....	49
Error code display .....	50
Displays and settings of the Bosch eBike Connect smartphone app.....	56
Activating the Bosch eBike Connect Application .....	56
Registration via Smartphone.....	56
Main menu of Bosch eBike Connect .....	58

<Activities> Menu Item .....	59
<Map> menu item .....	59
<My eBike> menu item .....	60
<Shop> Menu Item .....	60
Displays and settings of the online portal .....	62
Online registration .....	62
Online portal main menu .....	63
<Route Planning> Menu Item .....	63
<Activities> Menu Item .....	66
<My eBike> Menu Item .....	67
<Help> menu item .....	67
Profile menu item  .....	67
Maintenance and servicing .....	67
Maintenance and cleaning .....	68
After-sales service and advice on using products .....	68
Transport .....	68
Disposal .....	68

## Safety instructions



**Read all the safety information and instructions.** Failure to observe the safety information and follow instructions may result in electric shock, fire and/or serious injury.

### Save all safety warnings and instructions for future reference.

The term **battery** is used in these instructions to mean all original Bosch eBike rechargeable battery packs.

- ▶ **Read and observe the safety warnings and directions contained in all the eBike system operating instructions and in the operating instructions of your eBike.**
- ▶ **Do not allow yourself to be distracted by the on-board computer's display.** If you do not focus exclusively on the traffic, you risk being involved in an accident. If you want to make entries in your on-board computer other than switching the assistance level, stop and enter the appropriate data.
- ▶ **Set the display brightness so that you can adequately see important information such as speed and warning symbols.** Incorrectly set display brightness may lead to dangerous situations.
- ▶ **Before beginning any exercise programme, seek advice from a doctor about the level of activity that is suitable for you.** This is the only way to avoid potential physical overexertion.
- ▶ **When using a heart rate monitor, the heart rate displayed may be distorted by electromagnetic interference.** The heart rates displayed are for reference only. No liability can be accepted for consequences caused by incorrectly displayed heart rates.
- ▶ **Nyon is not a medical product.** The values displayed on the Fitness Screen may differ from the actual values.
- ▶ **Do not open the on-board computer.** Opening the on-board computer may damage it beyond repair and void any warranty claims.
- ▶ **Do not use the on-board computer as a handle.** Lifting the eBike up by the on-board computer can cause irreparable damage to the on-board computer.

- ▶ **The push assistance function must only be used when pushing the eBike.** There is a risk of injury if the wheels of the eBike are not in contact with the ground while using the push assistance.
- ▶ **When the push assistance is activated, the pedals may turn at the same time.** When the push assistance function is activated, make sure that there is enough space between your legs and the turning pedals to avoid the risk of injury.
- ▶ **When using the walk assistance, make sure that you can control the eBike and that you can hold it securely at all times.** Under certain circumstances, the walk assistance may stop (e.g. if the pedals hit an obstacle or if you accidentally let go of the button on the operating unit). The eBike may suddenly move backwards onto you or tip up. This presents a risk for the user particularly if there is additional load on the eBike. When using the walk assistance, do not bring the eBike into situations in which you cannot hold the eBike using your own strength.
- ▶ **Caution!** When using the on-board computer with *Bluetooth*<sup>®</sup> and/or WiFi, interference can occur with other devices and equipment, aircraft and medical devices (e.g. pacemakers, hearing aids). Likewise, injury to people and animals in the immediate vicinity cannot be excluded entirely. Do not use the on-board computer with *Bluetooth*<sup>®</sup> in the vicinity of medical devices, petrol stations, chemical plants, areas with a potentially explosive atmosphere or on blast sites. Do not use the on-board computer with *Bluetooth*<sup>®</sup> in aeroplanes. Avoid using the on-board computer near your body for extended periods.
- ▶ The *Bluetooth*<sup>®</sup> word mark and logos are registered trademarks owned by Bluetooth SIG, Inc. and any use of such marks by Bosch eBike Systems is under licence.

## Safety information relating to the navigation system

- ▶ **Do not plan your routes whilst you are cycling. Stop and wait until you are stationary before entering a new destination.** If you do not focus exclusively on the traffic, you risk being involved in an accident.
- ▶ **Abandon your route if the navigation system suggests a path or road that is too ambitious, risky or dangerous for you based on your cycling ability.** Have your navigation system propose an alternative route.

- ▶ **Do not ignore any road signs, even if the navigation system tells you to take a specific route.** The navigation system cannot take roadworks or temporary diversions into account.
- ▶ **Do not use the navigation system in situations that are safety-critical or unclear (road closures, diversions, etc.).** Always carry extra maps and means of communication with you.

## Privacy notice

If the on-board computer is sent to Bosch Service because it requires servicing, the data stored on the on-board computer may be transmitted to Bosch.



## Congratulations

Congratulations on purchasing your eBike computer.

Nyon takes over eBike control and gives you reliable information about all important riding data.

- eBike on-board computer with separate operating unit
- eBike, navigation, fitness and Internet functions
- Can be connected via *Bluetooth*<sup>®</sup> to a heart rate strap
- Wi-Fi connection to the **Bosch eBike Connect** portal

## Updates

Nyon's range of functions is continually being expanded. Keep your **Bosch eBike Connect** smartphone app up to date.

In addition to the functions shown here, changes to software relating to troubleshooting and functional enhancements may be introduced at any time.

Online tutorials on various functions can be accessed via the following link:  
<http://www.bosch-ebike.com/en/help-center/nyon-bui350>.

## Product description and specifications

### Intended use

The **Nyon (BUI350)** on-board computer is designed to control Bosch eBike systems and display trip data.

In addition to the functions shown here, changes to software relating to troubleshooting and functional modifications may be introduced at any time.

To find out more, visit: [www.Bosch-eBike.com](http://www.Bosch-eBike.com).

Instructions on how to use the app and the portal can be found in the online operating instructions at [www.Bosch-eBike.com](http://www.Bosch-eBike.com).

**Nyon (BUI350)** is not suitable for navigation without a bicycle (for hikers or motorists).

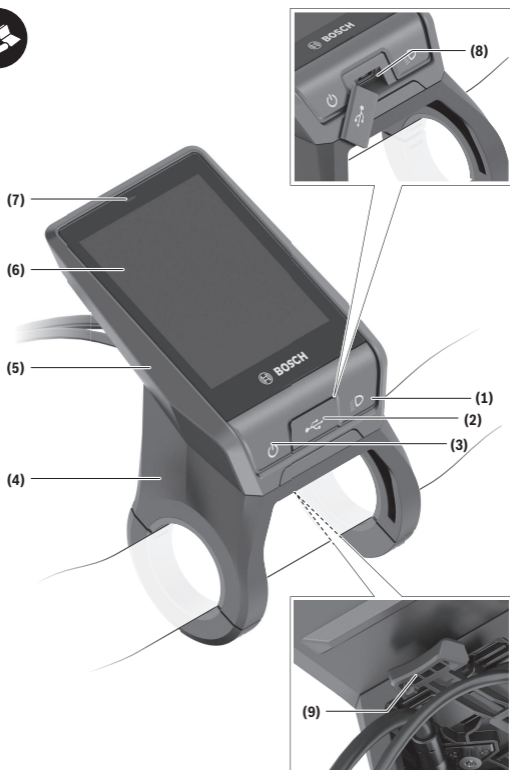

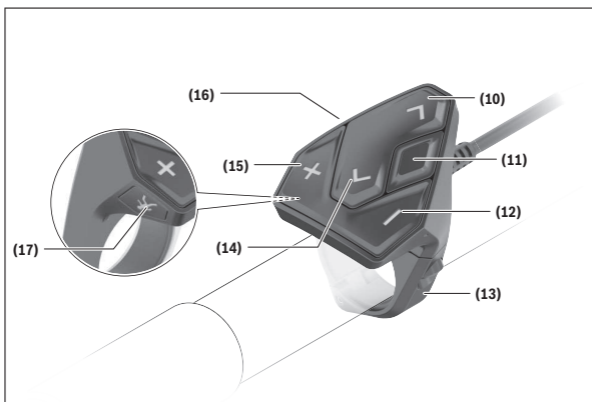

## Product Features

All illustrations of bike parts except for the drive unit, on-board computer (including operating unit), speed sensor and the corresponding holders are a schematic representation and may differ on your eBike.

- (1)** Bike light button
- (2)** Protective cap for the USB port
- (3)** On/off button for on-board computer
- (4)** Holder for on-board computer<sup>a)</sup>
- (5)** On-board computer
- (6)** Display (touch-sensitive)
- (7)** Brightness sensor
- (8)** USB port
- (9)** Release mechanism
- (10)** Next page button
- (11)** Select button
- (12)** Decrease assistance level button
- (13)** Holder for operating unit

**(14)** Previous page button

**(15)** Increase assistance level button

**(16)** Operating unit

**(17)** Start assistance/push assistance **WALK** button

- a) For mounting on the handlebars, custom solutions are possible even without the use of the handlebar clamps.

## Technical data

On-board computer		Nyon
Product code		BUI350
Total internal memory	GB	8
Max. charging current to USB port <sup>A)</sup>	mA	1500
Max. USB port charging voltage	V	5
USB charging cable		1 270 016 360
Operating temperature	°C	-5 to +40
Storage temperature	°C	+10 to +40
Charging temperature	°C	0 to +40
Internal lithium-ion battery	V	3.7
	mAh	1000
Protection rating		IP x5
Supported Wi-Fi standards		802.11b/g/n (2.4 GHz)
Weight, approx.	kg	0.2
Wi-Fi		
– Frequency	MHz	2400–2480
– Transmission power	mW	< 100
<i>Bluetooth®</i>		
– Frequency	MHz	2400–2480
– Transmission power	mW	< 10

A) Charging current to charge Nyon. External consumers cannot be charged.

## Declaration of Conformity

Robert Bosch GmbH, Bosch eBike Systems, hereby declares that the **Nyon** radio communication unit complies with Directive 2014/53/EU. The full text of the EU Declaration of Conformity is available to view at the following website: <https://www.bosch-ebike.com/conformity>.

Robert Bosch GmbH, Bosch eBike Systems, hereby declares that the **Nyon** radio communication unit complies with the Radio Equipment Regulations 2017 (SI 2917/1206). The full text of the UK Declaration of Conformity can be accessed at the following Internet address:  
<https://www.bosch-ebike.com/conformity>.

**UK  
CA**

The on-board computer has separate internal antennae for *Bluetooth*<sup>®</sup>, Wi-Fi and GPS with a power output. The antennae are not accessible to the user. Any change by the user contravenes the legal authorisation for this product.

## Fitting

- ▶ **Deactivate and remove the on-board computer when fitting or working on the holder.** This will avoid malfunctions/improper use.
- ▶ **Deactivate and remove the on-board computer when fitting or removing the securing screw.** This will avoid malfunctions/improper use.

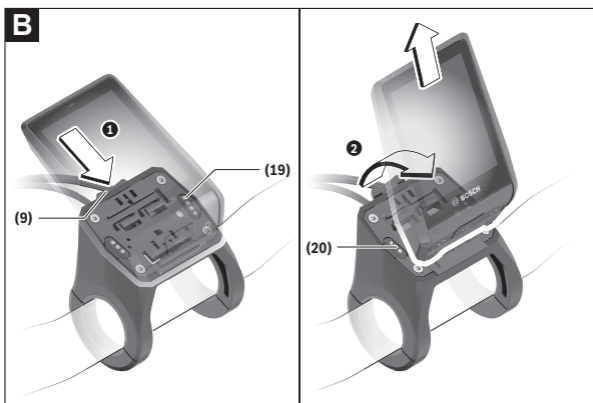
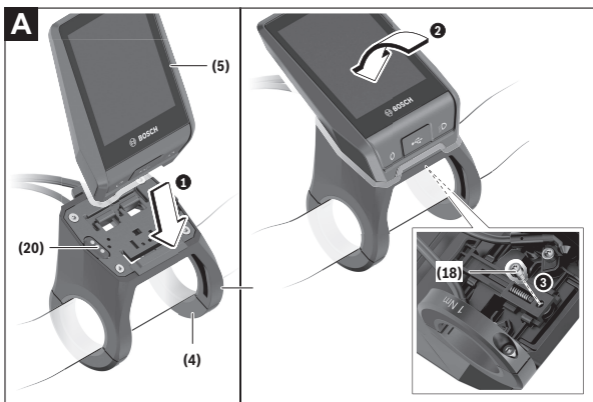

**(18)** Locking screw for on-board computer

**(19)** Drive unit contacts

**(20)** Operating unit contacts

## Inserting and removing the on-board computer (see figures A–B)

To **insert** the on-board computer **(5)**, first fit the lower part into the holder **(4)** and then press it forward until you can feel the on-board computer engage. Ensure that the on-board computer is firmly engaged.

To **remove** the on-board computer **(5)**, press the release mechanism **(9)** and remove the on-board computer upwards.

### ► **Remove the on-board computer when you park the eBike.**

It is possible to block the release mechanism with a screw. To do so, remove the holder **(4)** from the handlebars. Place the on-board computer in the holder. Screw the enclosed locking screw **(18)** (M3 thread, 5 mm long) from below into the thread provided in the holder. Fit the holder back onto the handlebars.

**Please note:** The locking screw is not designed to prevent theft.



# Operation

## Starting up the eBike system

### Requirements

The eBike system can only be activated when the following requirements are met:

- A sufficiently charged eBike battery is inserted (see operating instructions for the battery).
- The on-board computer is properly fitted in the holder.
- The on-board computer battery must be sufficiently charged.

### Switching the eBike system on/off

The following options are available for **switching on** the eBike system:

- Once the on-board computer and the eBike battery are fitted, briefly press the on/off button **(3)** on the on-board computer.
- With the on-board computer inserted, press the on/off button on the eBike battery (bicycle manufacturer-specific solutions are possible when there is no access to the battery on/off button; see the operating instructions from the bicycle manufacturer).

The drive is activated as soon as you start pedalling (except if you are using the walk assistance function or if the assistance level is set to **OFF**). The motor output adjusts to the assistance level set.

As soon as you stop pedalling when in normal operation, or as soon as you have reached a speed of **25/45 km/h**, the eBike drive switches off the assistance. The drive is automatically reactivated as soon you start pedalling again and the speed is below **25/45 km/h**.

The following options are available for **switching off** the eBike system:

- Press and hold the on/off button **(3)** on the on-board computer for at least 3 seconds.
  - Switch off the eBike battery using its on/off button (bicycle manufacturer-specific solutions are possible when there is no access to the battery on/off button; see the bicycle manufacturer operating instructions).
- Note:** This puts the **Nyon (BUI350)** into a standby mode.
- Remove the on-board computer from its holder.

If no power is drawn from the eBike drive for about **10** minutes (e.g. because the eBike is not moving) and no button is pressed on the on-board computer

or the control unit of the eBike, the eBike system will switch off automatically.

**Nyon (BUI350)** goes into standby mode as a result.

### Standby Mode

You can put your on-board computer into a standby mode, which enables the on-board computer and system to start up more quickly.

Standby mode can be activated as follows:

- To do this, press the on/off button **(3)** on the on-board computer for at least 1 second, but no longer than 3 seconds.
- Wait 10 minutes until the system switches off.
- Switch the battery off using the on/off button on the battery.

Pressing the on/off button **(3)** on the on-board computer for at least 1 second ends standby mode.

Standby mode ends and the on-board computer automatically switches off if the state of charge of the on-board computer's battery is less than 75 %. In any case, the on-board computer switches off at midnight (00:00) at the latest.

If **Nyon (BUI350)** cannot be switched on or does not work properly, press and hold the on/off button (for approx. 15 seconds). This may correct the malfunction.

### Power supply of the on-board computer

If the on-board computer is in the holder **(4)**, a sufficiently charged eBike battery is inserted into the eBike and the eBike system is switched on, then the on-board computer battery is powered and charged by the eBike battery.

If the on-board computer is removed from the holder **(4)**, the power is supplied by the on-board computer battery. The state of charge of the on-board computer battery is displayed in the top left corner of the status bar.

Colour of the indicator	Meaning
Green	The rechargeable battery of the on-board computer is over 30 % charged.
Orange	The rechargeable battery of the on-board computer is between 15 % and 30 % charged.

Colour of the indicator	Meaning
Red	The rechargeable battery of the on-board computer is charged 15 % or less.

If the on-board computer battery's charge is running low, a warning message appears on the display.

To charge the on-board computer battery, slide the on-board computer back onto the holder (4). Note that if you do not charge the eBike battery straight away, the eBike system will automatically switch off after 10 minutes of inactivity. If this happens, the on-board computer battery will also stop charging.

You can also charge the on-board computer via the USB port (8). To do this, open the protective cap (2). Use a Micro USB cable to connect the USB port on the on-board computer to a commercially available USB charger (not included with the product as standard) or to the USB port of a computer (max. 5 V charging voltage; max. 1500 mA charging current).

If the on-board computer's battery is not recharged, the date and time will be retained for approx. 6 months.

**Note:** To maximise the lifespan of the on-board computer's battery, it should be recharged for one hour every three months.

After use, the USB port must be carefully resealed with the protective cap (2).

► **USB connections are not waterproof. When cycling in the rain, do not connect any external devices and make sure that the USB port is fully sealed by the protective cover (2).**

It is not possible to charge external devices via the USB port.

## Battery Charge Indicator

The battery charge indicator for the eBike battery g (see "<Ride Screen>", page English – 35) can be read on the status bar. The eBike battery's state of charge is also indicated by the LEDs on the eBike battery itself.

Colour of the indicator	Meaning
Green	The eBike battery is over 30 % charged.

Colour of the indicator	Meaning
Orange	The eBike battery is between 15 % and 30 % charged.
Red	The eBike battery is between 0 % and 15 % charged.
Red + !	The capacity for assisting the drive has been used up, and assistance is switched off. The remaining capacity will be provided for the bike lights and the on-board computer.

If the eBike battery is being charged on the bike, a corresponding notification will be displayed.

If the on-board computer is removed from the holder **(4)**, the state of charge that was last displayed for the eBike battery is saved.

## Initial operation of the on-board computer

- ▶ **Before first use, remove the protective film from the display in order to ensure the full functionality of the on-board computer.** If the protective film remains on the display, this can impair the functionality/performance of the on-board computer.
- ▶ **The full functionality of the on-board computer cannot be guaranteed if the protective display film is used.**

Nyon is supplied with a partially charged battery. Before first use, the Nyon battery must be fully charged via the USB port or the eBike system.

When you switch on the on-board computer, you can set off after a short period of time (about 4 seconds). During the subsequent period, the on-board computer loads the complete operating system in the background.

**Note:** When switching on the on-board computer for the first time, the on-board computer requires a longer period before it is ready for use.

If the on-board computer is connected to the Wi-Fi, the user is informed of any new updates, where applicable. Download the update and install the latest version.

## Creating a User ID

To be able to use all functions of the on-board computer, you must register online.

With a user ID, you can analyse your ride data, plan offline routes and transfer these routes to the on-board computer.

You can set up a user ID via your **Bosch eBike Connect** smartphone app or simply at [www.ebike-connect.com](http://www.ebike-connect.com). Enter the details required for registration. The **Bosch eBike Connect** smartphone app is available to download free of charge from the App Store (for Apple iPhones) or from the Google Play Store (for Android devices).

### Connecting the On-board Computer with the Portal

Connect the on-board computer with the portal via a Wi-Fi connection.

**Note:** The on-board computer does not support the use of router channels 12 and 13. If, for example, your router is set as fixed on channel 12 or 13, these channels are not displayed in the list of available networks on the on-board computer. If necessary, adjust the settings of the router accordingly, in order to be able to connect the on-board computer with your network.

To do this, proceed as follows:

- Press **<Login>** on the **<Status Screen>**.
- Select **<WiFi>**.
- Select a network.
- Enter your username and password.

Once you have connected successfully, all data that you have shared in your profile in the portal is synchronised with the on-board computer.

### Connecting to the On-Board Computer using the Bosch eBike Connect App

Follow these steps to establish a connection to your smartphone:

- Load the app.
- Select the tab **<My eBike>**.
- Select **<Add new eBike device>**.
- Add **Nyon (BUI350)**.

The app will then display an instruction to press and hold the bike lighting button **(1)** on the on-board computer for 5 seconds.

Press and hold the button **(1)** for at least 5 seconds. The on-board computer automatically activates the *Bluetooth® Low Energy* connection and switches to pairing mode.

Follow the instructions on the screen. Once pairing is complete, the user data is synchronised.

**Note:** The *Bluetooth*® connection does not have to be activated manually.

## Setting the assistance level

On the operating unit **(16)**, you can set the level of assistance you want the eBike drive to provide you with while pedalling. The assistance level can be changed at any time, even while cycling.

**Note:** In some models, the assistance level may be preset and cannot be changed. There may also be fewer assistance levels available than stated here.

The following assistance levels are available as a maximum:

- **OFF:** Motor assistance is switched off. The eBike can only be moved by pedalling, as with a normal bicycle. The walk assistance cannot be activated at this assistance level.
  - **ECO:** Effective assistance with maximum efficiency, for maximum range
  - **TOUR/TOUR+:**
    - TOUR:** Steady assistance, long range for touring
    - TOUR+:** Dynamic assistance for natural, sporty cycling (only in conjunction with **eMTB**)
  - **SPORT/eMTB:**
    - SPORT:** Powerful assistance, for mountain biking and cycling in urban traffic
    - eMTB:** Optimum assistance whatever the terrain, rapid acceleration when starting from a standstill, improved dynamics and top performance (**eMTB** only available in combination with the drive units BDU250P CX, BDU365, BDU450 CX and BDU480 CX. A software update may be required.)
  - **TURBO:** Maximum assistance even at a high cadence, for sporty cycling
- To **increase** the assistance level, press the **+** button **(15)** on the operating unit repeatedly until the required assistance level appears on the indicator. To **decrease** the assistance level, press the **-** button **(12)**.

The requested motor output is displayed in the indicator **j**. The maximum motor output depends on the selected assistance level.

When the on-board computer is removed from the holder **(4)**, the assistance level that was last displayed is saved; the motor output indicator **j** remains empty.

## Switching the push assistance on/off

The walk assistance makes it easier to push your eBike. The speed in this function depends on the selected gear and can reach a maximum of **6 km/h**.

► **The push assistance function must only be used when pushing the eBike.** There is a risk of injury if the wheels of the eBike are not in contact with the ground while using the push assistance.

To **activate** the walk assistance, briefly press the **WALK** button on your on-board computer. Once it is activated, press the **+** button within 10 s and keep it held down. The eBike drive is now switched on.

**Note:** The push assistance cannot be activated at assistance level **OFF**.

The push assistance is **switched off** as soon as one of the following occurs:

- You release the **+** button;
- The wheels of the eBike are locked (e.g. by applying the brakes or hitting an obstacle);
- The speed exceeds **6 km/h**.

The push assistance function is subject to local regulations; the way it works may therefore differ from the description above, or the function may even be deactivated completely.

## Switching bicycle lights on/off

On the model on which the lighting is powered by the eBike system, the front and rear lights can be switched on and off at the same time via the on-board computer using the bike light button **(1)**.

Check that your bike lights are working correctly before every use.

With the light switched on, the lighting **f** indicator appears in the status bar on the display.

Switching the bike lights on and off has no effect on the backlighting of the display.

## Lock (premium function)

The Lock function is available for purchase from the **<Shop>** in the eBike Connect app. Once the Lock function has been set up and the Lock has been activated by removing the on-board computer, the eBike drive unit assistance is deactivated. It can only be activated using the on-board computer associated with the eBike.

The Lock function is linked to your **user account**, which you can use to log into the **eBike Connect app**. The account allows you to use the Lock function with an on-board computer, which in turn can be used to activate the function on up to 4 eBikes.

Note that 2 hours must have passed in between any 2 activations of the Lock function.

**Warning!** If you attempt to change a setting in the app, the on-board computer or the portal that could have negative consequences in combination with the Lock function (e.g. deleting your eBike or user account), you will be shown warning messages beforehand. **Please read through these thoroughly and adhere to the warnings that are issued (e.g. before deleting your eBike or user account).**

### Compatibility

The Lock function is compatible with these Bosch eBike product lines:

Drive unit	Product line
BDU3xx	Active Line, Active Line Plus, Performance Line
BDU4xx	Performance Line Speed, Cargo Line, Cargo Line Speed, Performance Line CX

### Setting up the Lock function

In order to be able to set up the lock function, the following conditions must be fulfilled:

- You have purchased the Lock function.
- The on-board computer is situated in the holder on the eBike.
- The on-board computer is connected to the smartphone via *Bluetooth®*.
- The smartphone is connected to the Internet.

Go to the **<My eBike>** menu item in your eBike Connect app and set up the Lock function for your eBike by sliding the control **<Lock feature>** to the right.

From now on, you can deactivate the assistance from your drive unit by removing the on-board computer. The drive unit assistance can only be reactivated with the on-board computer that was used in the setup.



Even with the Lock function activated, you can continue to use your eBike without assistance from the drive unit.

### How it works

In combination with the Lock function, the on-board computer functions similarly to a key for the drive unit. The Lock function is activated and deactivated by respectively removing or inserting the on-board computer. The status of the Lock function is indicated by a padlock symbol that appears on the display of the on-board computer for approx. three seconds following its insertion.

Remove the on-board computer from its holder whenever you are away from the eBike so that the Lock function can fulfil its intended purpose.

If the on-board computer used in setting up the Lock function is not inserted on your eBike, the drive unit will not provide any assistance. However, you can still continue to use your eBike without assistance.

**Note:** The Lock function alone does not provide adequate theft protection; it is simply a supplement to a mechanical lock. The Lock function does not provide any form of mechanical lock for the eBike. Only the assistance from the drive unit is deactivated.

If you wish to give other users temporary or permanent access to your eBike, you will need to deactivate the Lock function in the eBike Connect app.

If you remove the on-board computer, the drive unit will emit a "Lock" sound (i.e. an audio signal that is played **once**) to indicate that the assistance from the drive unit is switched off.

**Note:** The audio signal will only be played if the system is switched on.

If you reinsert the on-board computer, the drive unit will emit two "Unlock" sounds (i.e. an audio signal that is played **twice**) to indicate that the assistance from the drive unit is enabled again.

The "Lock" sound will help you determine whether or not the Lock function on your eBike is active. The audio signal is activated by default, but it can be deactivated under **<My eBike>** by selecting the lock symbol below your eBike.

In the eBike Connect app, the Lock function under **<My eBike>** is indicated with a lock symbol next to the bikes.

**Important:** The lock symbol is only shown for eBikes that are suitable for the Lock function. Note the information in the section on compatibility.

Please contact your bike dealer if any of the following occurs:

- The Lock function can no longer be set up or switched off
- Your eBike Connect account has been deleted or deactivated, yet the Lock function has been set up and remains active.

## Replacing eBike Components and the Lock Function

### Replacing the Smartphone

1. Install the eBike Connect app on the new smartphone.
2. Log in with **the same** account that was used to activate the Lock function.
3. Connect your smartphone with the on-board computer while the on-board computer is attached.
4. The Lock function is displayed as set up and active in the eBike Connect app.

### Replacing the on-board computer

1. Connect your smartphone with the on-board computer while the on-board computer is attached.
2. The Lock function is displayed as set up and active in the eBike Connect app.

### Replacing the drive unit

1. The Lock function is displayed as set up and deactivated in the eBike Connect app.
2. Activate the Lock function by sliding the **Lock function** control to the right.

## Activity tracking

In order to record activities, you must be registered with and logged into the eBike Connect portal or the eBike Connect app.

To record activities, you must consent to the storage of your location data in the portal and/or in the app. Without this, your activities will not be shown in the portal or the app. The position is recorded only if you are registered as a user on the on-board computer.

Once synchronisation is complete, the activities will be displayed in the app and in the portal whilst you are riding.

## eShift (optional)

eShift is the integration of electronic gear-shifting systems into the eBike system. The eShift components are electrically connected to the drive unit by the manufacturer. The separate operating instructions describe how to operate the electronic gear-shifting systems.

## ABS – anti-lock braking system (optional)

If the eBike is fitted with a Bosch eBike ABS, the indicator light is shown in the display of the on-board computer during the system start-up as well as in the event of a fault. The indicator light goes out as soon as you are riding the eBike faster than **6 km/h** and no fault is detected by the ABS. If an ABS fault occurs while riding, the indicator light in the display will warn you that the ABS is inactive. If you acknowledge the fault, the text **<ABS>** will appear in place of the state of charge. You can continue to ride, but will be reminded about the inactive status of the ABS.

For detailed information on the ABS and how it works, please refer to the ABS operating instructions.

## Software Updates

If **Nyon (BUI350)** is connected via Wi-Fi, checks for more recent software are carried out automatically. If a software update is available, the user is informed via a notification. Alternatively, the user can search for updates manually under **<System Settings>**.

## Notes on cycling with the eBike system

### Taking care of your eBike

Please observe the operating and storage temperatures of the eBike components. Protect the drive unit, on-board computer and battery against extreme temperatures (e.g. from intense sunlight without adequate ventilation). The components (especially the battery) can become damaged through extreme temperatures.

Keep the screen of your Nyon clean. Dirt can cause faulty brightness detection. The day/night changeover in navigation mode can be distorted.

An abrupt change in ambient conditions can cause the screen to fog up from inside. After a short time, the temperature equalises and the fog disappears.

## The Nyon operating system

The Nyon operating system consists of three components:

1. The Nyon on-board computer with operating unit
2. The **Bosch eBike Connect** smartphone app
3. The online portal at [www.ebike-connect.com](http://www.ebike-connect.com)

Many configurations and features can be managed and used on all components. Some configurations and features can be accessed or operated only via certain components. Data is synchronised automatically when a *Bluetooth*<sup>®</sup>/Internet connection is available. The following table provides an overview of the available features.

Functions of the online portal	③		
Functions of the smartphone app	②		
Functions of the on-board computer	①		
			
Login	✓	✓	✓
Registration		✓	✓
Changes settings	✓	✓	✓
Records riding data	✓		
Displays riding data in real time	✓		
Processes/analyses riding data		✓	✓
Creates user-defined displays	✓		
Current location indicator	✓ <sup>A)</sup>	✓ <sup>A)</sup>	✓
Navigation	✓		
Route planning	✓	✓	✓
Remaining range indicator (circle around the current location)	✓		

## Functions of the online portal

③

## Functions of the smartphone app

②

## Functions of the on-board computer

①

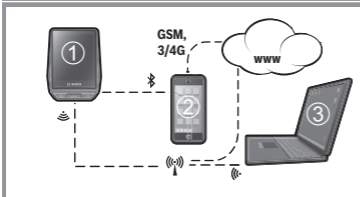

Training effect in real time

✓

Overview of journeys

✓

✓

Purchase of premium features

✓

A) GPS required

### Premium features

The standard features of the **Nyon (BUI350)** operating system can be extended via the App Store for Apple iPhones and Google Play Store for Android devices through the purchase of **premium features**.

In addition to the free **Bosch eBike Connect** app, there are several fee-based premium features. A detailed list of the additional apps that are available can be found in the online operating instructions at [www.Bosch-eBike.com](http://www.Bosch-eBike.com).

### User Administration

The first user to initially log into the on-board computer will automatically become the owner. If this user logs out and another user logs in, that user is assigned a guest role.

To name a new owner, the on-board computer must be reset to factory settings. The first user who logs in again after the reset is the new owner.

### Rights of the Owner

Even if the owner logs out, their activity data will remain saved until the next synchronisation.

**Note on locking:** Only the owner of Nyon can activate and deactivate the Lock function. If the Lock function is activated, a guest can still use the bike using the same Nyon as the owner.

### **Rights of the Guest**

After an owner has been defined on Nyon, each further user of a login will automatically become a guest.

If the guest logs out, all activity data that could not be synchronised before logout is automatically deleted.

## Displays and configurations of the on-board computer

**Please note:** All screenshots showing the display and text on the following pages are from the approved software version. The display and/or text may change slightly following a software update.

Nyon is fitted with a touch-sensitive screen. Swiping left or right scrolls between the individual screens. Tapping on the Status Screen opens functions or submenus.

Nyon has standard screens and preset screens. The user can also create their own screens. The user can set the order and number of screens. Max. 25 tiles can be used for the screens. The screens in these operating instructions are described as per the basic configuration of the on-board computer on delivery.

When Nyon is switched off, the last displayed screen is saved and displayed again next time it's switched on.

The first time Nyon is used and for certain screens, an introduction is automatically displayed. You can view these again at any time at **<Settings>** → **<Information>** → **<Introduction to Nyon>**.

The standard screens are:

- **<Status Screen>**
- **<Ride Screen>**
- **<Trip Data>**
- **<Map Screen>**
- **<Trip Analysis>**

The preset screens include:

- **<Fitness>**
- **<eMTB>**
- **<Basic>**

The preset screens with large display include:

- **<Savings>**
- **<Weather>**
- **<Goals>**
- **<Altitude Graph>**

You can use the < (14) and > (10) buttons to switch between the different riding value information pages (even while riding). This way, you can keep both hands on the handlebars while cycling.

You can use the + (15) and - (12) buttons to increase or decrease the assistance level.

The <Settings> that can be accessed via the <Status Screen> cannot be changed while riding.

## <Status Screen>

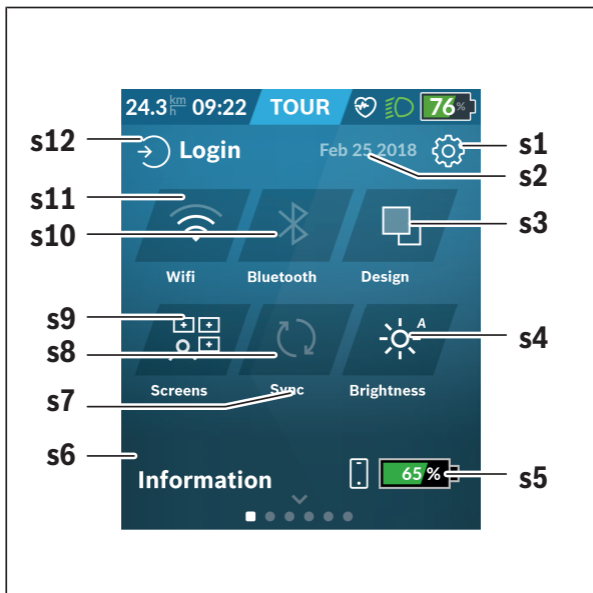

s1 <Settings> button

s2 Date



- s3 <Design>**  
This is where you can switch between light and dark backgrounds.
- s4 Button <Brightness>**  
This is where you can select from the following brightness levels:  
25% | 50% | 75% | 100% | Auto.  
To access the Brightness menu, press and hold the **<Brightness>** button. Auto mode can be individually adjusted here.
- s5 Smartphone battery charge**
- s6 <Information>**  
This is where recent events are displayed (e.g. maps download).
- s7 Time of last synchronisation**
- s8 Synchronisation button**
- s9 Button <Screens>**  
You can use this button to adjust the screen order and contents.
- s10 Button <Bluetooth>**  
**Tap:** Activate/deactivate  
**Press and hold:** Quick access to *Bluetooth*<sup>®</sup> menu
- s11 Button <WiFi>**  
**Tap:** Activate/deactivate  
**Press and hold:** Quick access to Wi-Fi<sup>®</sup> menu
- s12 <Login>**  
This is where the user can connect with their ID.

### **<Settings>**

You can gain access to the Settings menu via the **<Settings>** button.

The **<Settings>** cannot be accessed or changed while riding.

Tap the **<Settings>** button and select the required setting/the submenu.

Pressing the Back arrow in the menu bar gets you to the previous menu. You can close the Settings menu by pressing the **x** symbol (on the right in the menu bar).

You can find the following superordinate sections on the first settings level:

– **<Map Settings>**

Via **<Map Settings>**, the map display (2D/3D) can be selected, the downloaded maps and map updates checked and recommended maps downloaded. The system automatically checks which map matches your current location, and suggests regions and country maps in the direct surroundings.

– **<My eBike>** – Settings for your eBike:

The counters, such as average values or the number of kilometres travelled that day, can be reset to “0” either automatically or manually, and so can the range. You can change the wheel circumference value that was preset by the manufacturer by  $\pm 5\%$ . If your eBike features **eShift**, you can also configure your eShift system here. The bicycle dealer may base the service date on the distance travelled and/or on a period of time. The bike component page displays the serial number and hardware and software versions for each component, in addition to other key data which is relevant for the components.

– **<Screen Management>**

This menu item can be used to adapt the screen and tile contents to suit your personal requirements.

– **<Connections>**

The *Bluetooth*<sup>®</sup> and Wi-Fi connections can be set here. To be able to use the heart rate display, you must add either the **<Fitness>** from the preset screens or a heart rate tile to your standard screens. When you are connected, the heart symbol in the tile will go blue.

Recommended heart rate monitors:

- Polar H7
  - Polar H10 Heart Rate Sensor
  - Runtastic Heart Rate Combo Monitor
  - Wahoo TICKR Heart Rate Monitor
  - BerryKing Heartbeat chest strap
  - BerryKing Sportbeat armband
- May be compatible with other devices.

– **<My Profile>**

The data of the active user can be viewed here.

### – <System Settings>

You can display the speed and distance in kilometres or miles, display the clock in 12- or 24-hour format, adjust the time, date and time zone and select your preferred language. You can reset Nyon to factory settings, start a software update (if available) and choose between a black and white design. The time and the time zone are automatically updated via the satellite signal as soon as there's a connection.

### – <Information>

Information on FAQs, certifications, contact information, information on licences. You can find a detailed description of each parameter in the on-line operating instructions at [www.Bosch-eBike.com](http://www.Bosch-eBike.com).

### <Ride Screen>



- a** Speed
- b** Unit of speed
- c** Time<sup>a)</sup>  
The current time is shown according to the time zone selected. It is set automatically via GPS.
- d** Assistance level  
The colour of the screen changes depending on the assistance level.
- e** Connection to heart rate monitor  
Is also a placeholder for further events. The indicator is shown when the event occurs (e.g. connection to smartphone).
- f** Lighting  
The symbol is displayed if the lighting is switched on.
- g** Battery charge indicator of the eBike battery
- h** Range information<sup>b)c)</sup>
- i** Distance travelled
- j** Motor output
- k** Your performance
- w** Performance indicator

- a) For eBikes with ABS, the time is replaced with the **((ABS))** logo when the system starts or in the event of a fault with ABS.
- b) When navigation is **active**, a chequered flag at the end of the scale and the remaining distance to the destination are displayed. If the eBike battery has sufficient capacity, the right-hand side of the scale is green. If the right-hand side of the scale is orange or red, it is unsafe at the current assistance level or not possible to reach your destination with motor assistance. Selecting a lower assistance level may enable the remaining battery capacity to reach the required destination.
- c) When navigation is **not active**, kilometres travelled are displayed on the left and range on the right.

The **a ... g** indicators form the status bar and are shown on every screen.

When the on-board computer is removed from the holder, the status list changes:



- l** On-board computer battery charge  
If *Bluetooth*<sup>®</sup> and/or Wi-Fi connections are available, the corresponding icon is displayed in the centre.

- g Battery charge indicator of the eBike battery  
Latest state of charge of the eBike battery

## <Trip Data>

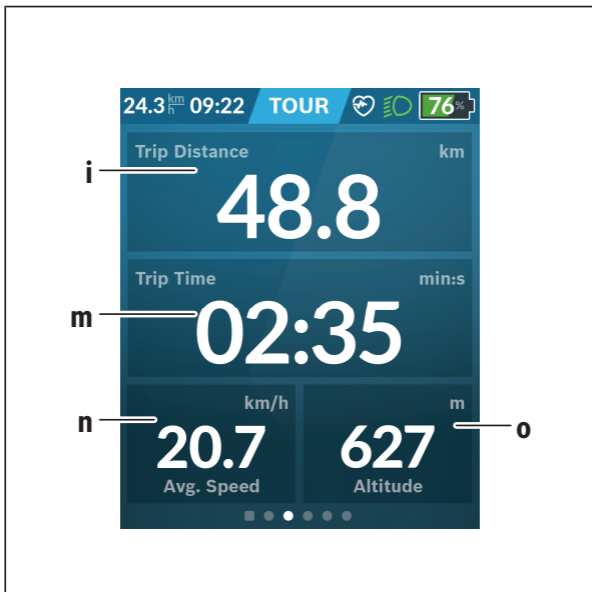

- i **<Trip Distance>**  
Trip distance indicator
- m **<Trip Time>**  
Trip time indicator
- n **<Avg. Speed>**  
Average speed indicator
- o **<Altitude>**  
Altitude above sea level indicator

## <Map Screen>

Navigation is carried out using map data based on Open Street Map (OSM). When you switch on Nyon, it begins the satellite search to receive GPS signals. When sufficient satellites have been found, the location point changes colour from grey to blue. In the case of unfavourable weather conditions or locations, the satellite search may take a little longer. If the application fails to find satellite signals over a prolonged period of time, restart Nyon.

The first search for satellites may take a few minutes.

To achieve the most accurate positioning, the first satellite search should be done outdoors. Ideally, stay stationary for a few minutes, even if the position has already be found.

When Nyon has determined your location, this will be shown on the map. To **increase the size** of the map section, touch the touchscreen with **two** fingers and spread them out. To **decrease the size** of the map section, pinch both fingers together. To **move** the map, simply move the map with both fingers on the screen. To **select a destination**, press and hold one finger on the map.

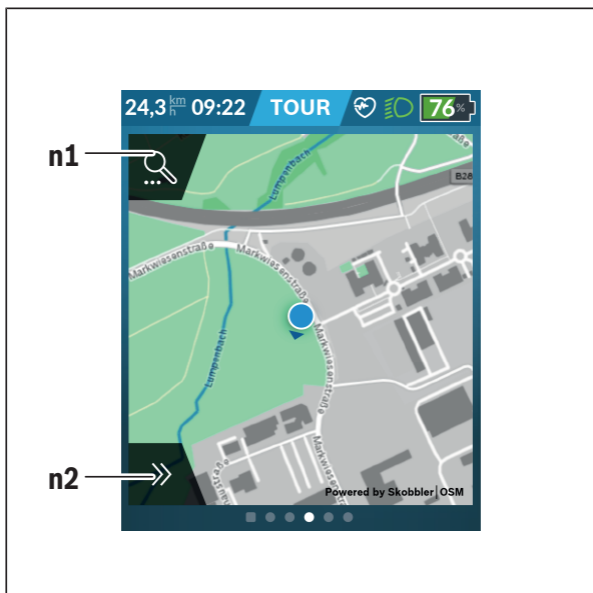

**n1** Navigation search

**n2** Navigation functions

In the navigation functions **n2**, you can select your destinations so that you can reach them using the current state of charge.

When navigation is active, the user receives information about whether it is possible to reach the destination with the current assistance mode and current state of charge of the eBike battery.

The circle around your location shows how far you can go, taking into consideration the assistance level set and the terrain ahead with the current battery charge. Changing the assistance level means that the circle adapts accordingly.

Selecting the navigation search **n1** brings up the following menu:

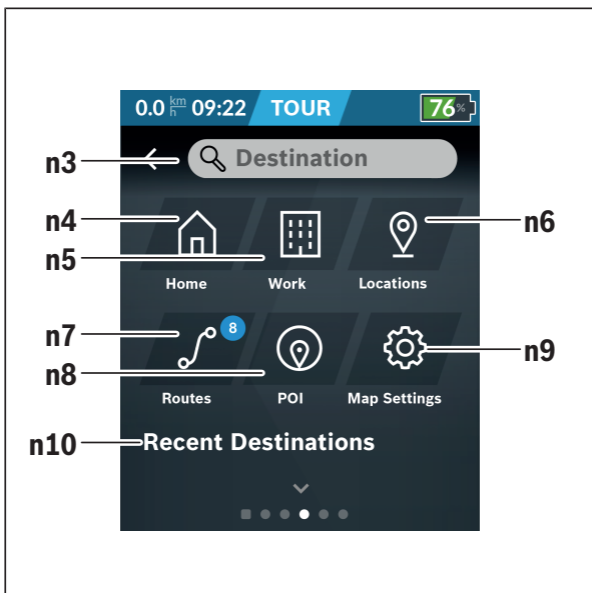

**n3** Input field **<Destination>**

Enter the address of your destination or a POI (e.g. a restaurant) here. Depending on what you enter, you are shown all possible addresses within 100 km.

The search results are always displayed in close proximity on the map. That helps you to assign the location faster for similar hits.

**n4** Button **<Home>**

Selecting this button guides you to your home address.<sup>a)</sup>

**n5** Button **<Work>**

Selecting this button guides you to your workplace.<sup>a)</sup>

**n6** Button **<Locations>**

Selecting this button means you can find your saved locations that have been synchronised by the app or the portal.



**n7** Button **<Routes>**

This displays the routes that have been saved in the portal, followed by the synchronised routes.

**n8** Button **<POI>**

Selecting this button means you can find destinations of general interest in your surrounding area, such as restaurants or shopping facilities.

The results are displayed in a list.



Tap on the symbol to have the results displayed on the map.

**n9** Button **<Map Settings>**

Selecting this button means you can change the map display or manage your maps.

The **<Map Color Style>** function can be found in the **<Map Settings>**.

- **<Auto>**: The map display is automatically adapted via the brightness sensor.
- **<Day Mode>**: The map display is always bright.
- **<Night Mode>**: The map display is always dark.
- **<As Background>**: The map display changes in relation to the selected colour scheme.

**n10** **<Recent Destinations>**

This is where your recent routes and locations are listed.

a) Data from the app and the portal is used and displayed.

When you have entered the destination, you are then shown the fastest route (**<Fast>**). Additionally, you can select the most scenic route (**<Scenic>**) or the route for mountain bikes (**<MTB>**). Alternatively, you can opt to be guided home (if you have entered your home address in the portal), select one of the recent destinations used, or choose from saved locations and routes.

The battery's remaining range is calculated and displayed, taking into consideration the topographical conditions. The calculation of the topographic range extends to no more than 100 km.

If you have imported or planned GPX routes via the online portal, these will be transferred to your Nyon via *Bluetooth*<sup>®</sup> or via a Wi-Fi connection. You can start these routes when you wish. If you are near a route, you can have the

navigation system guide you to the starting point or you can start navigating along the route immediately.

At temperatures below 0 °C, the elevation measurement is likely to deviate significantly.

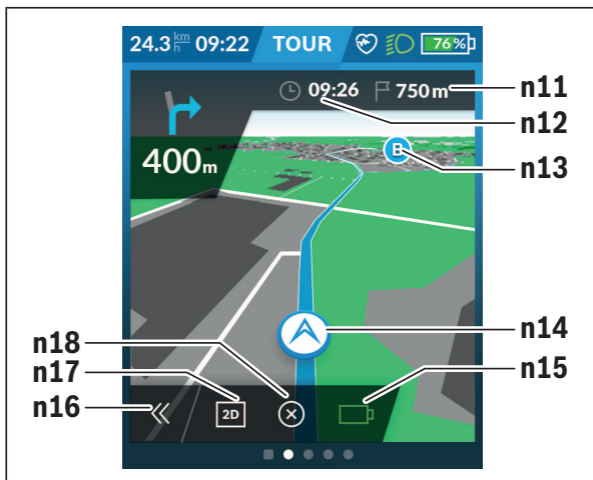

### Active Navigation

The following figure shows an example active navigation with explanations of the symbols depicted.



- n11** Distance to destination
- n12** Time of arrival
- n13** Destination
- n14** Current position
- n15** Battery range indicator
- n16** Open and close panel (back to search)
- n17** Switch between 2D and 3D view
- n18** End active navigation

The following functions are also available:

-  Centre view (only visible if the map has been moved or the zoom function has been used)
-  Skip waypoints (only visible if the route has been planned with intermediate destinations in the online portal)

### <AutoZoom 2D>



The <AutoZoom 2D> zoom function can be found in the <Map Settings>. The map section is optimally adapted depending on the speed.

### <Rerouting>

If you would like to follow a precisely defined route or a previously planned GPX track (e.g. on trails) exactly, you can deactivate recalculation of the route. The function can be activated and deactivated in the <Rerouting> menu item under <Map Settings>.

### Range Display

Once you have started navigation, you are shown whether the current state of charge of the rechargeable battery is sufficient to reach your destination. The range indicator **n15** changes colour and appearance depending on the calculated state of charge of the rechargeable eBike battery at the destination. The following table gives you an overview of the possible displays with regard to the state of charge of the rechargeable eBike battery.

Appearance	Colour	State of charge of the rechargeable eBike battery at the destination
	Green	> 30 %
	Orange	15 % to 30 %
	Red	0 % to 15 %

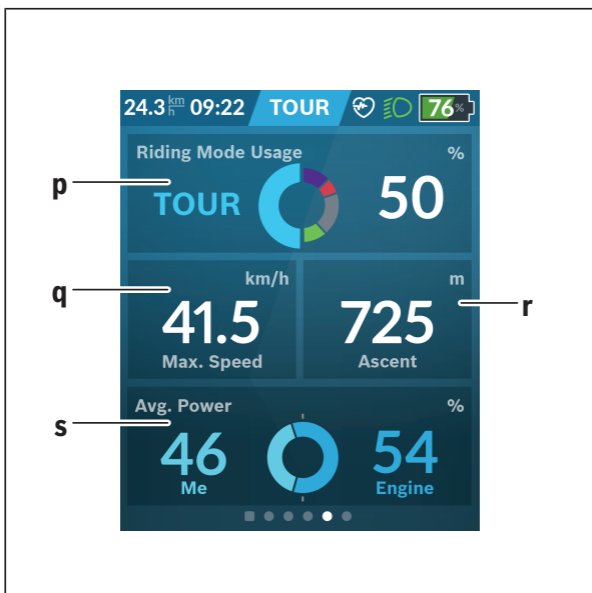
**<Trip Analysis>**

- p** **<Riding Mode Usage>**  
Indicator for usage of different riding modes
- q** **<Max. Speed>**  
Maximum speed indicator
- r** **<Ascent>**  
Ascent indicator
- s** **<Avg. Power>**  
Indicator for the ratio of your own power compared to motor power

**<Savings>**

Here you can compare savings against a car journey.

Tapping on the tile allows the view to be switched between saved monetary value and saved CO<sub>2</sub>. All values are accumulated for a single journey. The values for the week and the preceding week are accumulated and displayed. The values are set to 0 when the journey data is reset. The settings can be individually adapted via the Settings menu.

## Creating Your Own Screens

To integrate preset screens or create new screens, go to the Status Screen and select the **<Screens> s9** button. 4 icons are offered in the task bar to enable you to make changes.

You also have the option to start the function via **<Settings> → <Screens>**.

The following options are available:

- Move screens
- Create new screens
- Delete screens
- Add preset screens

When creating your own screen, you can add the **<Speed>**, **<Cadence>** and **<My Power>** tiles with an integrated performance indicator.

If the needle of the performance indicator is on the left-hand side, the background will turn orange. This means that your performance is below the average value.

If the needle of the performance indicator is on the right-hand side or in the middle, the background will turn green. This means that your performance is greater than or equal to the average value.

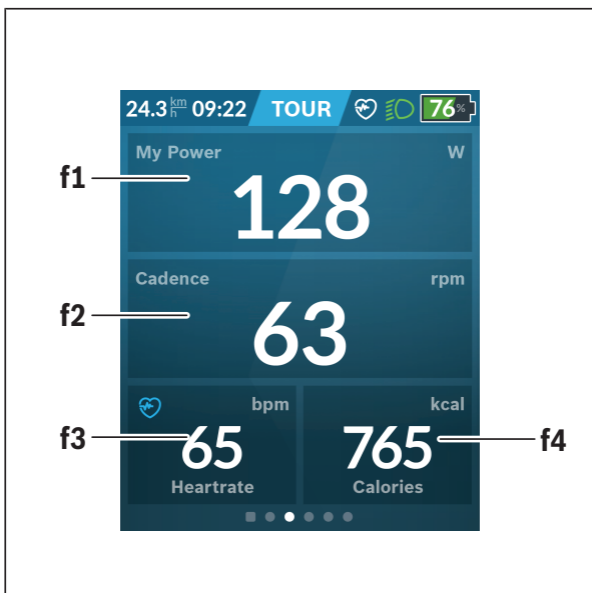
**<Fitness> (preset screen)**

- f1**    **<My Power>**  
Your power indicator
- f2**    **<Cadence>**  
Cadence indicator
- f3**    **<Heart Rate>**  
Heart rate indicator
- f4**    **<Calories>**  
Calories burned indicator

## Determine destinations

Here you can determine and pursue your weekly and monthly destinations. Tapping on the **<Goals>** tile allows you to switch between weekly destinations, monthly destinations and an annual overview.

The following destinations can be individually defined:

- **<Calories>**
- **<Distance>**
- **<Ascent>**
- **<Riding Time>**

## <eMTB> (preset screen)



**t** **<Slope>**  
Ascent indicator

- o**    **<Altitude>**  
Altitude above sea level indicator
- u**    **<Altitude Graph>**  
Altitude graph indicator
- v**    **<Max. Slope>**  
Maximum slope indicator
- r**    **<Ascent>**  
Ascent indicator

### **<Basic> (preset screen)**

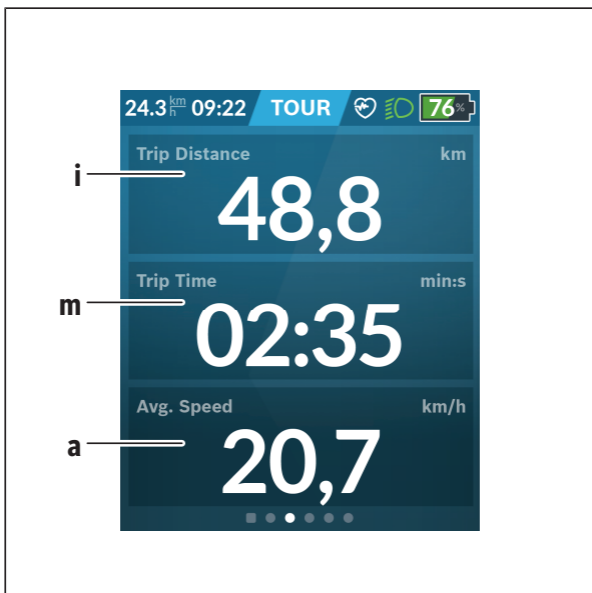

- i**    **<Trip Distance>**  
Trip distance indicator



- m**    **<Trip Time>**  
Trip time indicator
- a**    **<Avg. Speed>**  
Average speed indicator

## **<Quick Menu>**

Selected settings are displayed on the quick menu. These settings can also be changed while riding.

You can access the quick menu via the select button **(11)**. You can switch between the submenus with the **< (14)** and **> (10)** buttons. Select the items on the submenu using the **+ (15)** and **- (12)** buttons.

You cannot access the **<Quick Menu>** from the **<Status Screen>**.

The following submenus can be accessed from the **<Quick Menu>**:

- **<Trip Data>**  
This submenu allows you to reset all data on the journey so far to zero.
- **<Select Destination>**  
Via this submenu, you can save your current position, return to a saved position or receive directions to take you home.
- **<Map Zoom>**  
This submenu allows you to increase or decrease the size of the map section.
- **<Brightness>**  
This submenu allows you to select from the following brightness levels: 25 % | 50 % | 75 % | 100 % | Auto.
- **<Design>**  
This submenu allows you to select a light or dark background.
- **<eShift>** (optional)  
This submenu allows you to set the cadence.
- **<Custom Riding Modes>** (premium function, obtainable via the App Store or Google Play Store)  
Via this submenu, you can select custom riding modes.
- **<Quick Menu>**  
This submenu allows you to exit the **<Quick Menu>**.

## Error code display

The eBike system's components are continuously and automatically monitored. If an error is detected, the corresponding error code is displayed on the on-board computer.

The drive may be automatically shut down, depending on the type of error. However, if you wish to continue cycling, you will always be able to do so without assistance from the drive. Before undertaking any other journeys, the eBike should be checked.

► **Have all repairs performed only by an authorised bike dealer.**

Code	Cause	Corrective measures
410	One or more buttons of the on-board computer are disabled.	Check whether any buttons are stuck, e.g. as a result of dirt finding its way in. Clean the buttons if need be.
414	Operating unit connection problem	Have the connections checked
418	One or more buttons on the operating unit are disabled.	Check whether any buttons are stuck, e.g. as a result of dirt finding its way in. Clean the buttons if need be.
419	Configuration error	Restart the system. If the problem persists, contact your Bosch eBike dealer.
422	Drive unit connection problem	Have the connections checked
423	eBike battery connection problem	Have the connections checked
424	Communication problem between components	Have the connections checked
426	Internal time-out error	Restart the system. If the problem persists, contact your Bosch eBike dealer. With this error, it is not possible to bring up the wheel circumference in the basic settings menu or to adjust it.
430	Internal battery of the on-board computer is flat	Charge the on-board computer (in the holder or via the USB port)

Code	Cause	Corrective measures
	(does not apply to BUI350)	
431	Software version error	Restart the system. If the problem persists, contact your Bosch eBike dealer.
440	Internal drive unit fault	Restart the system. If the problem persists, contact your Bosch eBike dealer.
450	Internal software error	Restart the system. If the problem persists, contact your Bosch eBike dealer.
460	Error at USB port	Remove the cable from the USB port of the on-board computer. If the problem persists, contact your Bosch eBike dealer.
490	Internal fault of the on-board computer	Have the on-board computer checked
500	Internal drive unit fault	Restart the system. If the problem persists, contact your Bosch eBike dealer.
502	Bike light fault	Check the light and the associated wiring. Restart the system. If the problem persists, contact your Bosch eBike dealer.
503	Speed sensor fault	Restart the system. If the problem persists, contact your Bosch eBike dealer.
504	Speed signal distortion detected.	Check that the spoke magnet is positioned correctly, and adjust it if necessary. Check that nothing has been tampered with (tuning). Drive assistance is reduced.
510	Internal sensor fault	Restart the system. If the problem persists, contact your Bosch eBike dealer.
511	Internal drive unit fault	Restart the system. If the problem persists, contact your Bosch eBike dealer.
530	Battery fault	Switch off the eBike, remove the eBike battery and reinsert the eBike battery.

Code	Cause	Corrective measures
		Restart the system. If the problem persists, contact your Bosch eBike dealer.
531	Configuration error	Restart the system. If the problem persists, contact your Bosch eBike dealer.
540	Temperature error	The eBike is outside of the permissible temperature range. Switch off the eBike system and allow the drive unit to either cool down or heat up to the permissible temperature range. Restart the system. If the problem persists, contact your Bosch eBike dealer.
550	An impermissible load has been detected.	Remove the load. Restart the system. If the problem persists, contact your Bosch eBike dealer.
580	Software version error	Restart the system. If the problem persists, contact your Bosch eBike dealer.
591	Authentication error	Switch off the eBike system. Remove the battery pack and reinsert it. Restart the system. If the problem persists, contact your Bosch eBike dealer.
592	Incompatible component	Use a compatible display. If the problem persists, contact your Bosch eBike dealer.
593	Configuration error	Restart the system. If the problem persists, contact your Bosch eBike dealer.
595, 596	Communication error	Check the wiring to the drive and restart the system. If the problem persists, contact your Bosch eBike dealer.
602	Internal battery fault	Restart the system. If the problem persists, contact your Bosch eBike dealer.
603	Internal battery fault	Restart the system. If the problem persists, contact your Bosch eBike dealer.
605	Battery temperature error	The battery is outside of the permissible temperature range. Switch off the eBike

Code	Cause	Corrective measures
		system and allow the battery to either cool down or heat up to the permissible temperature range. Restart the system. If the problem persists, contact your Bosch eBike dealer.
606	External battery fault	Check the wiring. Restart the system. If the problem persists, contact your Bosch eBike dealer.
610	Battery voltage error	Restart the system. If the problem persists, contact your Bosch eBike dealer.
620	Charger fault	Replace the charger. Contact your Bosch eBike dealer.
640	Internal battery fault	Restart the system. If the problem persists, contact your Bosch eBike dealer.
655	Multiple battery faults	Switch off the eBike system. Remove the battery pack and reinsert it. Restart the system. If the problem persists, contact your Bosch eBike dealer.
656	Software version error	Contact your Bosch eBike dealer so that they can perform a software update.
7xx	Error relating to third-party components	Observe the information in the operating instructions of the respective component manufacturer.
800	Internal ABS fault	Contact your Bosch eBike dealer.
810	Implausible signals from the wheel speed sensor	Contact your Bosch eBike dealer.
820	Fault in the wire to the front wheel speed sensor	Contact your Bosch eBike dealer.
821 to 826	Implausible signals from the front wheel speed sensor	Restart the system and carry out a test ride lasting at least two minutes. The ABS indicator light must go out. If the problem persists, contact your Bosch eBike dealer.

Code	Cause	Corrective measures
	The sensor disc may be missing, defective or fitted incorrectly; there is a significant difference in diameter between the front wheel and the rear wheel; extreme riding situation, e.g. riding solely on the rear wheel	
830	Fault in the wire to the rear wheel speed sensor	Contact your Bosch eBike dealer.
831 833 to 835	Implausible signals from the rear wheel speed sensor  The sensor disc may be missing, defective or fitted incorrectly; there is a significant difference in diameter between the front wheel and the rear wheel; extreme riding situation, e.g. riding solely on the rear wheel	Restart the system and carry out a test ride lasting at least two minutes. The ABS indicator light must go out. If the problem persists, contact your Bosch eBike dealer.
840	Internal ABS fault	Contact your Bosch eBike dealer.
850	Internal ABS fault	Contact your Bosch eBike dealer.
860, 861	Fault in the power supply	Restart the system. If the problem persists, contact your Bosch eBike dealer.
870, 871 880 883 to 885	Communication error	Restart the system. If the problem persists, contact your Bosch eBike dealer.
889	Internal ABS fault	Contact your Bosch eBike dealer.

Code	Cause	Corrective measures
890	ABS indicator light is defective or missing; ABS may not be working.	Contact your Bosch eBike dealer.
No display	Internal fault of the on-board computer	Restart your eBike system by switching it off and back on.

## Displays and settings of the Bosch eBike Connect smartphone app

A smartphone is not included with the product. An Internet connection is required for registering with a smartphone. Depending on the contract, this can incur costs from your telephone provider. An Internet connection is also required for synchronising data between the smartphone and online portal.

**Please note:** All screenshots showing the display and text on the following pages are from the approved software version. Since a software update may be implemented over the course of the year, it is possible that the display and/or text of the interface may change.

The following description of the eBike Connect app applies to the Kiox (BUI330) and Nyon (BUI27x and BUI350) on-board computers.

### Activating the Bosch eBike Connect Application

In order to be able to use all eBike Connect functions, it is necessary to have a smartphone with the **Bosch eBike Connect** application.

Proceed as follows to perform activation:

1. Open the Google Play store (Android) or the App Store (iOS) on your smartphone.
2. Search for **Bosch eBike Connect**.
3. Install the **Bosch eBike Connect** application and open it.
4. Register as described in the next section.

If you have already registered via the online portal ([www.ebike-connect.com](http://www.ebike-connect.com)), you can also log in directly with your login data.











### Registration via Smartphone



- Start the **Bosch eBike Connect** application.
- Select **<Sign up>**.
- Read and accept the terms and conditions and the privacy policy.
- After confirming these, an e-mail will be sent to the address you have specified with the provisions of the agreement.
- Activate your user account by clicking on the button in the e-mail you have received.



If the application **Bosch eBike Connect** is active and there is a *Bluetooth*<sup>®</sup> connection to your on-board computer, data between on-board computer and smartphone will sync automatically.

## Main menu of Bosch eBike Connect

Symbol	Menu Item	Function
	<b>&lt;Feed&gt;</b>	This menu item contains an overview of the number of kilometres that have been travelled over the last month, a display indicating the latest activity undertaken that has not yet been completed, and the latest news updates.
	<b>&lt;Activities&gt;</b>	Under this menu item, you can view the trips you have made.
	<b>&lt;Map&gt;</b>	You can plan routes via this menu item. Saved routes are automatically synchronised between the app and the on-board computer (does not apply to BUI330).
	<b>&lt;My eBike&gt;</b>	Under this menu item, you can select your on-board computer and adjust your eBike settings.
	<b>&lt;More&gt;</b>	Click this button to display additional menu items.
	<b>&lt;Shop&gt;</b>	Under this menu item, you can purchase premium functions that are compatible with your product.
	<b>&lt;Settings&gt;</b>	Under this menu item, you can view and edit your personal data, data protection settings and app settings, and also download maps for offline use of the app.
	<b>&lt;Help&gt;</b>	This menu item contains <b>&lt;FAQs&gt;</b> , i.e. answers to frequently asked questions.
	<b>&lt;System Status Page&gt;</b>	This menu item contains a link to the status overview for the apps and portals.
	<b>&lt;Corporate Information&gt;</b>	This menu item contains contact details for the manufacturer.
	<b>&lt;Terms and conditions&gt;</b>	This menu item contains the general terms and conditions.

Symbol	Menu Item	Function
	<b>&lt;Data Protection Notice&gt;</b>	Under this menu item, you can find out about the data protection terms.
	<b>&lt;Service Description&gt;</b>	Under this menu item, you can learn more about the different services.
	<b>&lt;About&gt;</b>	This menu item contains information such as the current version of the app, contract partners, the developers and the licence information.

### **<Activities> Menu Item**

Under the **<Activities>** menu item, you can see the routes taken that were not previously planned in the online portal (e.g. via Komoot).

Following successful synchronisation, your journeys will be shown on the map in the portal. The synchronisation status is displayed on the on-board computer.

When you select a journey, you will be shown the trip distance, the trip duration, the average speed, and also the route travelled on a map. In addition, three further pages with driving statistics data are available.

### **<Map> menu item**

The map displayed here is intended for viewing and destination input, but navigation – as with Google Navigation, for instance – is not possible.

When you have selected this menu item, your current location will be shown using the GPS function of the smartphone.

You can select saved locations via the search function. It is also possible to input a destination by clicking on the map.

Once you have entered the destination, you will be offered three different routes (**<Fast>**, **<Scenic>** and **<Mountain bike>**) displaying the elevation profile.

- The **<Fast>** route shows you the fastest connection from your location to your selected destination while avoiding steeper slopes.
- The **<Scenic>** route shows you the most scenic connection from your location to your selected destination and avoids main roads.
- The **<Mountain bike>** route guides you over mostly unpaved trails and offers the best route for a mountain bike (not for eBikes up to 45 km/h).

**Note:** The different **<Fast>**, **<Scenic>** and **<Mountain bike>** routes may be identical on short routes.

If you are using **Nyon**, the planned route is automatically transmitted to **Nyon** as soon as there is a connection between the app and Nyon.

If you are using **Kiox**, then you transmit the planned route by selecting the button for starting the route, and confirm with OK once you have read the safety instructions.

In addition to route planning, you will find your previously saved destinations and routes in the search history.

Under saved routes, you can also access planned routes via the Komoot app, if you have previously connected to Komoot.

Starting from your current location, you can also navigate home or to work.

### **<My eBike> menu item**

When installing the app for the first time, a connection between the app and the on-board computer is established via this menu item.

To do this, select **<Add new eBike device>** and follow the instructions.

Following successful pairing, the currently connected on-board computer and the associated eBike components will be displayed.

The eBikes that have been connected with Kiox or Nyon are shown.

If the on-board computer has already been placed on at least two different eBikes, they are displayed here for selection. Otherwise, it is not possible to make a selection. The name assigned to each eBike can be changed in the online portal, or an eBike can be deleted from the selection list.

### **<Shop> Menu Item**

If you are using **Nyon (BUI350)**, you have the option of expanding the functionality of your on-board computer to include premium functions via the **<Shop>** menu item.

### **Lock**

By setting up and activating the Lock, you can remove the on-board computer to deactivate the eBike drive unit assistance. The drive unit can only be activated using the on-board computer associated with the eBike (see "Lock (premium function)", page English – 23).

### <Custom riding modes>

Four different riding modes can be configured with this extension. This means that, for each of the four riding modes, the assistance level of the motor support can be set depending on the speed at four points.

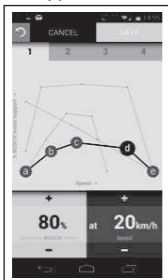

You can configure four different riding modes however you like.

When setting, five definable **checkpoints** or steps are available to you. For the middle three points you can select any desired performance assistance for a certain speed. For the left exterior point, only the performance assistance can be changed (speed is fixed at 0 km/h). For the right exterior point, only the maximum speed can be changed (performance assistance is fixed at 0 %). The speed is plotted on the horizontal x-axis and the performance assistance on the vertical y-axis in percent. If you are happy with the definition, save the riding mode. The riding mode is then automatically transmitted to Nyon if there is a *Bluetooth*<sup>®</sup> connection.

## Displays and settings of the online portal

**Please note:** All screenshots showing the display and text on the following pages are from the approved software version. Since a software update may be implemented over the course of the year, it is possible that the display and/or text of the interface may change.

The following description of the online portal applies to **Kiox** and **Nyon**.

### Online registration

Internet access is required for online registration.

- Use your browser to open the **Bosch eBike Connect** online portal at [www.ebike-connect.com](http://www.ebike-connect.com).
- Read and accept the terms and conditions and the privacy policy.
- Follow the instructions and complete the registration.

Once you have registered, you can log in with your e-mail address and password from this point on. Alternatively, you can also log in via **Facebook login**. An existing Facebook profile is required for **Facebook login**. The login data of the online portal matches the login data of the **Bosch eBike Connect** smartphone application.

## Online portal main menu

Menu item	Function
<b>&lt;Dashboard&gt;</b>	Your most recent activities, statistical data, news and tips are displayed via this menu item.
<b>&lt;Route Planning&gt;</b>	You can plan new routes via this menu item.
<b>&lt;Activities&gt;</b>	Under this menu item, you can view the trips you have made.
<b>&lt;My eBike&gt;</b>	Under this menu item, you can manage your eBike components and create user-defined views.
<b>&lt;Help&gt;</b>	Under this menu item you will find the FAQ, contact details and other information.
	You can manage your profile via this menu item.

### <Route Planning> Menu Item

The **<Route Planning>** menu item comprises the following submenus:

- **<Build route>**
- **<Explore>**
- **<My Routes>**
- **<Import GPX track>**

#### <Build route>





By specifying the start and end point, you can plan a new route. If required, you can add further intermediate destinations by entering the address.

Addresses or coordinates can be entered in decimal format as start and end points or an intermediate destination. Alternatively, an element can be selected from the list of recent destinations, saved locations or points of interest.

In the map, you add further intermediate destinations by dragging a point from a route. By right-clicking, you can add a new end point or delete an existing point. The start and end point as well as the intermediate points on the map can be moved.

The waypoints planned in the online portal are displayed in Nyon. Upcoming waypoints can be skipped. When you have reached or skipped the intermediate destinations, you get a message. It is not possible to plan waypoints directly with Nyon.

The following symbols are used to display the route type:

Symbol	Explanation
	<Planned Route without waypoints>
	<Planned Route with waypoints>
 GPX	<GPX with active guidance (incl. turn-by-turn advices)>
 GPX	<GPX without active guidance (no turn-by-turn advices)>

You can choose between three different routes (<Fast>, <Scenic> and <MTB>).

- The <Fast> route shows you the fastest connection from your location to your selected destination while avoiding steeper slopes.
- The <Scenic> route shows you the most scenic connection from your location to your selected destination and avoids main roads.
- The <MTB> route guides the cyclist over mostly unpaved trails and offers the best route for mountain bikers (**not** for eBikes up to 45 km/h).

The different <Fast>, <Scenic> and <MTB> routes may be identical on short routes.

The currently selected route is displayed on the map. In addition, the uphill/downhill gradient, distance and expected trip duration of the selected route are displayed.

When you have compiled your desired route, save it by pressing <Save>.

The saved routes and locations are synchronised with the **eBike Connect** app once they have been saved.

In addition, you can plan the route as a round trip (<Plan as round trip>).

If you have an S-Pedelec, the online portal offers you only tracks that are suitable for this eBike type.



If you have connected both a normal Pedelec and an S-Pedelec with the account, you can switch between both eBike types in route planning.

If you are using **Nyon**, the planned route is automatically transmitted to **Nyon** as soon as there is a connection between the app and Nyon.

### <Explore>

Under the **<Explore>** menu item, tour suggestions for your surrounding area are offered to you through the "Outdooractive" partner.

You can select one or several tours, which you can save under **<My Routes>**.

### <My Routes>

All your saved routes can be accessed and changed here.

If you are using **Nyon**, the route can be started directly. You do not need a smartphone.

If you are using **Kiox**, the route can only be started via a smartphone.

A route is automatically synchronised if your on-board computer is connected to the Wi-Fi (only with Nyon) or the eBike Connect smartphone app.

### <Import GPX track>

GPX files contain a number of geographical coordinates (waypoints), which constitute a route according to their sequence. These GPX files can be used for navigation with the Kiox and Nyon on-board computers. You can create or edit GPX files with the appropriate programs.

Using the **<Import GPX track>** button, you can import GPX files of up to 5 MB to the online portal. The GPX files are saved in the background. The on-board computers themselves cannot import GPX files directly via a USB connection.

The routability of GPX tracks depends on the accuracy of details on OSM maps. Depending on whether there are streets and paths on which you can ride, the following results are possible.

If you are using **Kiox**:

- GPX track is synchronised on the smartphone.
- GPX track is fully routable.

Navigation is only possible if the remaining distance is specified. If Kiox is close to the starting point, navigation can be started immediately. If Kiox is further away from the starting point, then you must first make your way to the starting point.

- GPX track is not routable.  
The route is displayed statically on Kiox and can be travelled by the rider. No distance can be displayed.
- GPX track is partially routable.  
If you use the changed versions, you can convert and save the route into a fully routable track. If you have the original version, the route is treated as a non-routable track.

#### If you are using **Nyon**:

- The GPX track is synchronised if Nyon is connected to the Internet. If Nyon does not have an Internet connection but is connected to a smartphone via *Bluetooth*<sup>®</sup>, the GPX track is synchronised via the smartphone.
- GPX track is fully routable.  
As usual, navigation including turn-by-turn instructions and the specification of the remaining distance and estimated time of arrival is possible. The turn-by-turn instructions can be switched off by pressing the button in the top right. If Nyon is close to the starting point, navigation can be started immediately. If Nyon is further away from the starting point, the rider can be navigated to that point.
- GPX track is not routable.  
The route is displayed statically on Nyon and can be travelled by the rider. No navigation details or time calculations can be made.
- GPX track is partially routable.  
If you use the changed versions, you can convert and save the route into a fully routable track. If you have the original version, the route is treated as a non-routable track.

#### **<Activities> Menu Item**

In the overview, you can see a summary of all the activities you have recorded to date. You can look over individual activities in detail under the **<Activities>** menu item.

Following successful synchronisation, your journeys will be shown on the map in the portal. The synchronisation status is displayed on the on-board computer.

If you select a journey, additional statistical data will be provided alongside the route length and journey duration. The route travelled will be displayed on a map. You can display up to two journey-related parameters in the form of a diagram.

If you use a chest strap, your heart rate is also displayed.

Activities which are not complete are also displayed following synchronisation.

Under **<Options>**, you have the option of exporting the completed activity to various formats or converting the activity into a route.

If you have linked your account with Facebook, you can share the completed activity with your friends on Facebook.

### **<My eBike> Menu Item**

Under **<My eBike>**, you can manage your eBike components, and create and adapt custom riding modes (only with Nyon).

### **<Help> menu item**

In the **<Help>** menu item, you will find a selection of FAQs (frequently asked questions), contact details, legal information and information about the system and licences.

### **Profile menu item**



Under **<My profile>**, you can adapt your profile:

- Under **<My profile>**, you can change the e-mail address and password, and adjust your fitness data and personal data.
- You can also select your preferred language for the portal interface here.
- You can delete your account on **eBike Connect**.

Under **<Privacy settings>**, you can influence the collection and control of your personal data. The following setting options are available:

- **<Geolocation data>**  
Here you can switch off storage of the location data.
- **<Newsletter>**  
Here you can register for the e-mail newsletter.
- **<Delete all your eBike activities>**  
Here you can delete all eBike activities.

Under **<Connected apps>**, you can connect to the apps of Bosch partners, consequently synchronising your activities with these apps.

## **Maintenance and servicing**

- ▶ **Deactivate the on-board computer if carrying out cleaning, maintenance or service work on the holder or on-board computer.** This is the only way to avoid malfunctions/improper use.

## Maintenance and cleaning

Do not clean any of the components with pressurised water.

Keep the screen of your on-board computer clean. Dirt can cause faulty brightness detection.

Clean your on-board computer using a soft cloth dampened only with water. Do not use cleaning products of any kind.

Have your eBike system checked by an expert at least once a year (including mechanical parts, up-to-dateness of system software).

In addition, the bicycle dealer may base the service date on the distance travelled and/or on a period of time. In this case, the on-board computer displays a message telling you when the service date is due each time it is switched on.

Please have your eBike serviced and repaired by an authorised bicycle dealer.

► **Have all repairs performed only by an authorised bike dealer.**

## After-sales service and advice on using products

If you have any questions about the eBike system and its components, contact an authorised bicycle dealer.

For contact details of authorised bike dealerships, please visit [www.bosch-ebike.com](http://www.bosch-ebike.com).

## Transport

► **If you transport your eBike attached to the outside of your car, e.g. on a bike rack, remove the on-board computer and the eBike battery to avoid damaging them.**

## Disposal



The drive unit, on-board computer incl. operating unit, battery, speed sensor, accessories and packaging should be disposed of in an environmentally correct manner.

Check that your personal data has been deleted from the device.

Do not dispose of eBikes and their components with household waste.



In accordance with Directive 2012/19/EU and Directive 2006/66/EC respectively, electronic devices that are no longer usable and defective/drained batteries must be collected separately and recycled in an environmentally friendly manner.

Please return Bosch eBike components that are no longer usable free of charge to an authorised bicycle dealer or to a recycling facility.

**Subject to change without notice.**

**Robert Bosch GmbH**

72757 Reutlingen

Germany

**[www.bosch-ebike.com](http://www.bosch-ebike.com)**

**1 270 020 Nen (2022.07) T / 70**