

Kiox

Online-Version (BUI330)



en Original operating instructions



Table of contents

| | |
|---|----|
| Safety instructions | 6 |
| Privacy notice..... | 7 |
| Congratulations | 8 |
| Product description and specifications..... | 8 |
| Intended use | 8 |
| Product features | 10 |
| Technical data | 11 |
| Declaration of Conformity | 11 |
| Fitting..... | 12 |
| Fitting and removing the on-board computer (see figure A) | 12 |
| Operation | 14 |
| Operating logic | 14 |
| Before initial commissioning | 14 |
| Switching the on-board computer on/off..... | 14 |
| Battery charge indicator | 15 |
| Selecting system settings | 15 |
| Starting up the eBike system..... | 16 |
| Requirements | 16 |
| Switching the eBike system on/off | 16 |
| Power supply of the on-board computer | 17 |
| Storage mode/resetting the Kiox | 18 |
| Setting the assistance level..... | 18 |
| Switching the push assistance on/off | 19 |
| Switching bicycle lights on/off..... | 20 |
| Creating a User ID | 20 |
| Connecting to the on-board computer using the Bosch eBike Connect app | 20 |
| Software updates..... | 21 |
| Activity tracking | 21 |
| Lock (premium function)..... | 21 |
| Compatibility..... | 22 |

| | |
|--|----|
| Setting up the Lock function | 22 |
| How it works..... | 22 |
| Replacing eBike Components and the Lock Function | 24 |
| ABS – anti-lock braking system (optional)..... | 24 |
| eSuspension (optional)..... | 24 |
| eShift (optional) | 25 |
| Powering external devices via the USB port..... | 25 |
| Displays and settings of the on-board computer..... | 26 |
| Order of pages..... | 26 |
| Start page | 27 |
| Status screen | 28 |
| <Settings> | 29 |
| Quick Menu | 30 |
| Error code display | 32 |
| Displays and Settings of the Bosch eBike Connect Smartphone App | 38 |
| Activating the Bosch eBike Connect Application | 38 |
| Registration via Smartphone..... | 38 |
| Main menu of Bosch eBike Connect | 40 |
| <Activities> menu item | 41 |
| <Map> menu item..... | 41 |
| <My eBike> menu item | 41 |
| Displays and settings of the online portal | 43 |
| Online registration | 43 |
| Online portal main menu | 44 |
| <Route Planning> menu item..... | 44 |
| <Activities> menu item | 46 |
| <My eBike> menu item | 46 |
| <Help> menu item | 46 |
| <My profile> menu item | 46 |
| Maintenance and servicing | 48 |
| Maintenance and cleaning | 48 |
| After-sales service and advice on using products | 48 |
| Transport..... | 48 |

| | |
|----------------|----|
| Disposal | 48 |
|----------------|----|

Safety instructions



Read all the safety information and instructions. Failure to observe the safety information and follow instructions may result in electric shock, fire and/or serious injury.

Save all safety warnings and instructions for future reference.

The term **battery** is used in these instructions to mean all original Bosch eBike rechargeable battery packs.

- ▶ **Do not allow yourself to be distracted by the on-board computer's display.** If you do not focus exclusively on the traffic, you risk being involved in an accident. If you want to make entries in your on-board computer other than switching the assistance level, stop and enter the appropriate data.
- ▶ **Do not open the on-board computer.** Opening the on-board computer may damage it beyond repair and void any warranty claims.
- ▶ **Do not use the on-board computer as a handle.** Lifting the eBike up by the on-board computer can cause irreparable damage to the on-board computer.
- ▶ **Do not stand your bicycle upside down on its saddle and handlebars if the on-board computer or its holder protrude from the handlebars.** This may irreparably damage the on-board computer or the holder. Also remove the on-board computer before placing the bicycle on a wall mount to ensure that the on-board computer does not fall off or become damaged.
- ▶ **Caution!** When using the on-board computer with *Bluetooth*[®] and/or WiFi, interference can occur with other devices and equipment, aircraft and medical devices (e.g. pacemakers, hearing aids). Likewise, injury to people and animals in the immediate vicinity cannot be excluded entirely. Do not use the on-board computer with *Bluetooth*[®] in the vicinity of medical devices, petrol stations, chemical plants, areas with a potentially explosive atmosphere or on blast sites. Do not use the on-board computer with *Bluetooth*[®] in aeroplanes. Avoid using the on-board computer near your body for extended periods.
- ▶ The *Bluetooth*[®] word mark and logos are registered trademarks owned by Bluetooth SIG, Inc. and any use of such marks by Bosch eBike Systems is under licence.

- ▶ **The on-board computer is equipped with a wireless interface. Local operating restrictions, e.g. in aeroplanes or hospitals, must be observed.**

Privacy notice

If the on-board computer is sent to Bosch Service because it requires servicing, the data stored on the on-board computer may be transmitted to Bosch.

Congratulations

Congratulations on purchasing your eBike computer.

Kiox controls your eBike and reliably displays all your key ride data.

- eBike on-board computer with separate operating unit
- Can be connected via *Bluetooth*[®] to a heart rate

Updates

The Kiox's range of functions is always being expanded.

In addition to the functions shown here, changes to software relating to troubleshooting and functional enhancements may be introduced at any time.

Product description and specifications

Intended use

The Kiox on-board computer is designed to control Bosch eBike systems and display riding data.

To access the full functionality of the Kiox on-board computer, you will need a compatible smartphone installed with the eBike Connect app (available from the App Store or Google Play) and a registration with the eBike Connect portal (www.ebike-connect.com).

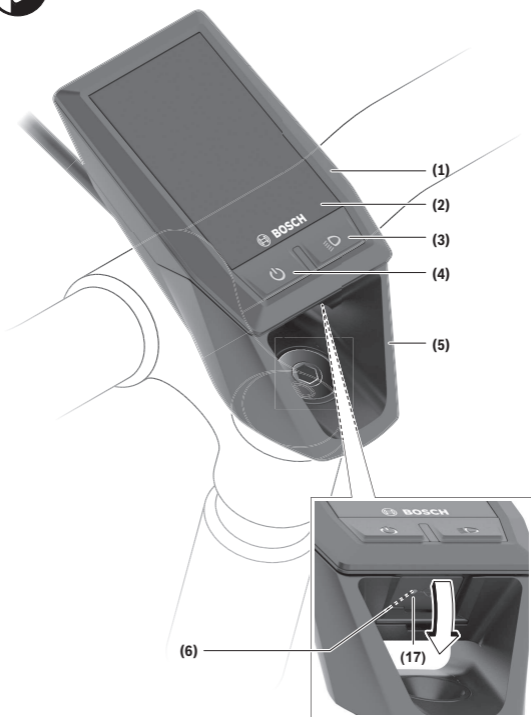

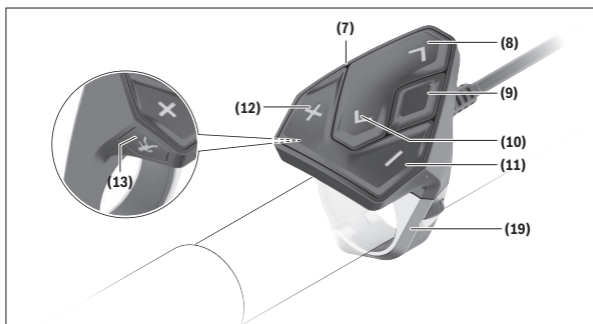

Product features

- (1)** On-board computer
- (2)** Display
- (3)** Bike light button
- (4)** On/off button for on-board computer
- (5)** Holder for on-board computer
- (6)** USB port
- (7)** Operating unit
- (8)** Next/right page button >
- (9)** Select button
- (10)** Previous/left page button <
- (11)** Decrease assistance level button -/
Scroll down button
- (12)** Increase assistance level button +/
Scroll up button
- (13)** Push assistance button
- (17)** Protective cap for USB port^{A)}
- (19)** Holder for operating unit

A) Available as spare part

Technical data

| On-board computer | | Kiox |
|---|-----|---------------|
| Product code | | BUI330 |
| Max. charging current of USB port ^{A)} | mA | 1000 |
| USB port charging voltage | V | 5 |
| USB charging cable ^{B)} | | 1 270 016 360 |
| Operating temperature | °C | -5 to +40 |
| Charging temperature | °C | 0 to +40 |
| Storage temperature | °C | -10 to +50 |
| Internal lithium-ion battery | V | 3.7 |
| | mAh | 230 |
| Protection rating ^{C)} | | IP x7 |
| Weight, approx. | g | 60 |
| <i>Bluetooth® Low Energy</i> | | |
| – Frequency | MHz | 2400–2480 |
| – Transmission power | mW | < 10 |

A) At an ambient temperature of <25 °C

B) Not included as part of standard delivery

C) When the USB cover is closed

Declaration of Conformity

Robert Bosch GmbH, Bosch eBike Systems, hereby declares that the **Kiox** radio communication unit complies with Directive 2014/53/EU. The full text of the EU Declaration of Conformity can be accessed at the following Internet address: <https://www.ebike-connect.com/conformity>

Fitting

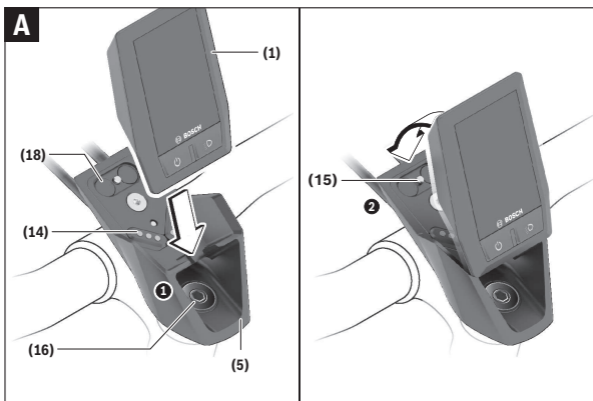

- (1) On-board computer
- (5) Holder for on-board computer
- (14) Drive unit contacts
- (15) Locking screw for on-board computer
- (16) Headset screw
- (18) Magnetic holder

Fitting and removing the on-board computer (see figure A)

Fit the lower part of the Kiox into the holder (5) first and tilt it forward gently until you can feel that the on-board computer is firmly fixed in the magnetic holder.

To remove the on-board computer, hold it by the top end and pull it towards you until it disengages from the magnetic holder.

► Remove the on-board computer when you park the eBike.

The on-board computer can be secured in place to prevent it from being removed from the holder. To do this, loosen the headset screw (16) until the

Kiox holder can be swivelled sideways. Put the on-board computer in the holder. Screw the locking screw (M3 thread, 6 mm long) from below into the thread provided in the on-board computer (using a longer screw may damage the on-board computer). Swivel the holder back into place and tighten the headset screw in accordance with the manufacturer's specifications.

Operation

Operating logic

You can use the **< (10)** and **> (8)** buttons to switch between the different riding value information pages (even while riding). This way, you can keep both hands on the handlebars while cycling.

You can use the **+ (12)** and **- (11)** buttons to increase or decrease the assistance level.

The **<Settings>** that can be accessed via the **Status screen** cannot be changed while riding.

You can use the select button **(9)** to perform the following functions:

- You can access the quick menu while riding.
- You can access the settings menu from the **Status screen** while stationary.
- You can confirm values and acknowledge informative hints.
- You can exit a dialogue.

If the on-board computer is removed from its holder and not switched off, it will display information regarding the last journey, as well as status information, on a loop.

If no button is pressed after the on-board computer is removed from the holder, it will switch itself off after 1 minute.

Before initial commissioning

The **Kiox** is supplied with a partially charged battery. Before using it for the first time, this battery must be charged for at least one hour via the USB port (see "Power supply of the on-board computer", page English – 17) or via the eBike system.

The control unit should be attached such that the buttons are almost perpendicular to the handlebars.

When using the on-board computer for the first time, the language selection page is displayed initially. You can then choose to have essential functions and indications explained via the **<Intro to Kiox>** menu item. The menu item can also be called up at a later time via **<Settings> → <Information>**.

Switching the on-board computer on/off

To **switch on** and **switch off** the on-board computer, briefly press the on/off button **(4)**.

Battery charge indicator

The battery charge indicator of the eBike battery **d** (see "Start page", page English – 27) can be read on the status page and in the status bar. The eBike battery's state of charge is also indicated by the LEDs on the eBike battery itself.

| Colour of the indicator | Explanation |
|-------------------------|---|
| White | The eBike battery is over 30 % charged. |
| Yellow | The eBike battery is over 15 % charged. |
| Red | The capacity for assisting the drive has been used up, and assistance is switched off. The remaining capacity will be provided for the bike lights and the on-board computer. |

If the eBike battery is being charged on the wheel, a corresponding notification will be displayed.

If the on-board computer is removed from the holder **(5)**, the state of charge that was last displayed for the battery is saved.

Selecting system settings

Fit the on-board computer in the holder and proceed as follows while the bicycle is stationary:

Go to the status page (use the **<** button **(10)** on the operating unit to get to the first display) and press the select button **(9)** to call up the **<Settings>**.

You can use the **-** **(11)** and **+** **(12)** buttons to select the setting you want. You can open the settings, as well as any additional submenus, using the select button **(9)**. You can use the **<** button **(10)** to go back to the previous menu from any settings menu.

The following settings can be changed in the **<Sys settings>**:

- **<Brightness>**

The brightness can be adjusted in steps of 10 % from 0–100 %. The values can be adjusted with the **</>** buttons and selected with the **+/-** buttons. When the **<Automatic>** option is selected, the brightness automatically adjusts to the ambient light.

- **<Time>**

The values can be adjusted with the **</>** buttons and selected with the **+/-** buttons.

- **<Date [DD.Mon.YYYY]>**
The current date can be set here.
- **<Time zone>**
The correct time zone can be selected here.
- **<24h form (24h time format)>**
This time format can be switched on or off.
- **<Brgh backg. (Bright background)>**
The bright background can be switched on or off.
- **<Imp. units (Imperial units)>**
If this option is switched on, imperial measurements are used (e.g. miles instead of kilometres).
- **<Language>**
The required language for the interface can be selected here from 9 options.
- **<Factory reset>**
This menu item can be used to reset the on-board computer to factory settings.

Starting up the eBike system

Requirements

The eBike system can only be activated when the following requirements are met:

- A sufficiently charged eBike battery is inserted (see operating instructions for the battery).
- The on-board computer is properly fitted to the holder.

Switching the eBike system on/off

The following options are available for **switching on** the eBike system:

- Once the on-board computer and the eBike battery are fitted, briefly press the on/off button **(4)** on the on-board computer.
- With the on-board computer inserted, press the on/off button on the eBike battery (bicycle manufacturer-specific solutions are possible when there is no access to the battery on/off button; see the operating instructions from the bicycle manufacturer).

The drive is activated as soon as you start pedalling (except if you are using the push-assistance function or if the assistance level is set to **OFF**). The motor output depends on the settings of the assistance level on the on-board computer.

As soon as you stop pedalling when in normal operation, or as soon as you have reached a speed of **25/45 km/h**, the eBike drive switches off the assistance. The drive is automatically reactivated as soon as you start pedalling again and the speed is below **25/45 km/h**.

The following options are available for **switching off** the eBike system:

- Briefly press the on/off button **(4)** of the on-board computer.
- Switch off the eBike battery using its on/off button (bicycle manufacturer-specific solutions are possible when there is no access to the battery on/off button; see the bicycle manufacturer operating instructions).
- Remove the on-board computer from its holder.

If no power is drawn from the eBike drive for about 10 minutes (e.g. because the eBike is not moving) and no button is pressed on the on-board computer or the operating unit of the eBike, the eBike system, and therefore also the battery, will switch off automatically to save energy.

Power supply of the on-board computer

If the on-board computer is in the holder **(5)**, a sufficiently charged eBike battery is inserted into the eBike and the eBike system is switched on, then the on-board computer battery is powered and charged by the eBike battery.

If the on-board computer is removed from the holder **(5)**, the power is supplied by the on-board computer battery. If the on-board computer battery's charge is running low, a warning message appears on the display.

To charge the on-board computer battery, slide the on-board computer back onto the holder **(5)**. Note that if you do not charge the eBike battery straight away, the eBike system will automatically switch off after 10 minutes of inactivity. If this happens, the on-board computer battery will also stop charging.

You can also charge the on-board computer via the USB port **(6)**. To do this, open the protective cap **(17)**. Use a Micro USB cable to connect the USB port on the on-board computer to a commercially available USB charger (not included with the product as standard) or to the USB port of a computer (max. **5 V** charging voltage; max. **500 mA** charging current).

If the on-board computer is removed from the holder **(5)**, all values for the functions are saved and can still be scrolled through.

If the Kiox battery is not recharged, the date and time will be retained for up to 6 months. When the on-board computer is switched on again, the date

and time will be reset if a *Bluetooth*[®] connection to the app has been established and the smartphone has successfully identified the current location via GPS.

Note: The Kiox **only** charges while it is switched on.

Note: If the Kiox is switched off during charging via a USB cable, the Kiox can only be switched on again once the USB cable has been disconnected.

Note: To maximise the lifespan of the on-board computer's battery, it should be recharged for one hour every three months.

Storage mode/resetting the Kiox

The on-board computer has an energy-saving storage mode which minimises the rate at which the internal battery discharges. Setting to this mode erases the date and time.

This mode can only be activated by pressing and holding the on/off button **(4)** of the on-board computer for at least 8 seconds.

If the on-board computer does not start when the on/off button **(4)** is pressed briefly, the on-board computer is in storage mode.

You can deactivate storage mode by pressing the on/off button **(4)** for at least 2 seconds.

The on-board computer detects whether it is in a fully functional condition. If you press and hold the on/off button **(4)** for at least 8 seconds while in a fully functional condition, the on-board computer will go into storage mode. If, contrary to expectations, the Kiox is not in a fully functional condition and cannot be operated, pressing and holding the on/off button **(4)** (for at least 8 seconds) will reset it. After being reset, the on-board computer will restart automatically after approx. 5 seconds. If the Kiox does not restart, press the on/off button **(4)** for 2 seconds.

To reset the Kiox to its factory settings, select **<Settings>** → **<Sys settings>** → **<Factory reset>**. All user data will be lost.

Setting the assistance level

On the operating unit **(7)**, you can set the level of assistance you want the eBike drive to provide you with while pedalling. The assistance level can be changed at any time, even while cycling.

Note: In some models, the assistance level may be preset and cannot be changed. There may also be fewer assistance levels available than stated here.

The following assistance levels are available as a maximum:

- **OFF:** Motor assistance is switched off. The eBike can just be moved by pedalling, as with a normal bicycle. The push assistance cannot be activated at this assistance level.
- **ECO:** Effective assistance with maximum efficiency, for maximum range
- **TOUR:** Steady assistance, long range for touring
- **SPORT/eMTB:**
 - SPORT:** Powerful assistance, for mountain biking and cycling in urban traffic
 - eMTB:** Optimum assistance whatever the terrain, rapid acceleration when starting from a standstill, improved dynamics and top performance (**eMTB** only available in combination with the drive units BDU250P CX, BDU365, BDU450 CX and BDU480 CX. A software update may be required.)
- **TURBO:** Maximum assistance even at high pedalling speeds, for sport cycling

To **increase** the assistance level, press the **+ (12)** button on the operating unit repeatedly until the desired assistance level appears on the display. To **decrease** the assistance level, press the **- (11)** button.

The requested motor output appears on the display **h** (see "Start page", page English – 27). The maximum motor output depends on the selected assistance level.

If the on-board computer is removed from the holder **(5)**, the assistance level that was last displayed is saved.

Switching the push assistance on/off

The push assistance aids you when pushing your eBike. The speed in this function depends on the selected gear and can reach a maximum of **6 km/h**. The lower the selected gear, the lower the speed of the push assistance function (at full power).

► **The push assistance function must only be used when pushing the eBike.** There is a risk of injury if the wheels of the eBike are not in contact with the ground while using the push assistance.

To **activate** the push assistance, briefly press the **WALK** button on your on-board computer. After activation, press the **+** button within 3 s and keep it pressed. The eBike drive is switched on.

Note: The push assistance cannot be activated at assistance level **OFF**.

The push assistance is **switched off** as soon as one of the following occurs:

- You release the **+** button;
- The wheels of the eBike are locked (e.g. by applying the brakes or hitting an obstacle);
- The speed exceeds **6 km/h**.

The push assistance function is subject to local regulations; the way it works may therefore differ from the description above, or the function may even be deactivated completely.

Switching bicycle lights on/off

On the model in which the lighting is powered by the eBike system, the front and rear lights can be switched on and off at the same time via the on-board computer using the bike light button **(3)**.

With the light switched on, the lighting **c** indicator (see "Start page", page English – 27) appears in the status bar on the display.

Switching the bike lights on and off has no effect on the backlighting of the display.

Creating a User ID

In order to use all the features of the operating system, you must also register online.

With a user ID, you can analyse your ride data, plan offline routes and transfer these routes to the on-board computer.

You can set up a user ID via your **Bosch eBike Connect** smartphone app or simply at www.eBike-Connect.com. Enter the details required for registration. The **Bosch eBike Connect** smartphone app is available to download free of charge from the App Store (for Apple iPhones) or from the Google Play store (for Android devices).

Connecting to the on-board computer using the Bosch eBike Connect app

Follow these steps to establish a connection to your smartphone:

- Load the app.
- Select the tab **<My eBike>**.
- Select **<Add new eBike device>**.
- Add **Kiox**.

The app will then display an instruction to press and hold the bike lighting button **(3)** on the on-board computer for 5 seconds.

Press and hold the button **(3)** for at least 5 seconds. The on-board computer automatically activates the *Bluetooth® Low Energy* connection and switches to pairing mode.

Follow the instructions on the screen. Once pairing is complete, the user data is synchronised.

Note: The *Bluetooth®* connection does not have to be activated manually.

Software updates

Software updates are transferred to the on-board computer in the background of the app as soon as it is connected to the app. When an update is complete, this will be displayed the next **three times** the on-board computer is restarted.

Alternatively, you can check in the **<Sys settings>** whether an update is available.

Activity tracking

In order to record activities, you must be registered with and logged into the eBike Connect portal or the eBike Connect app.

To record activities, you must consent to the storage of your location data either in the portal or the app. Without this, your activities will not be shown in the portal or the app. Your position is only recorded if the on-board computer is connected to the eBike Connect app.

Once synchronisation is complete, the activities will be displayed in the app and in the portal.

Lock (premium function)

The Lock function is available to purchase from the **<Shop>** in the eBike Connect app. Once the Lock function has been set up and the Lock has been activated by removing the on-board computer, the eBike drive unit assistance is deactivated. It can only be activated using the on-board computer associated with the eBike.

The Lock function is linked to your **user account**, which you can use to log into the **eBike Connect app**. The account allows you to use the Lock function with an on-board computer, which in turn can be used to activate the function on up to 4 eBikes.

Note that 2 hours must have passed in between any 2 activations of the Lock function.

Warning! If you attempt to change a setting in the app, the on-board computer or the portal that could have negative consequences in combination with the Lock function (e.g. deleting your eBike or user account), you will be shown warning messages beforehand. **Please read through these thoroughly and adhere to the warnings that are issued (e.g. before deleting your eBike or user account).**

Compatibility

The Lock function is compatible with these Bosch eBike product lines:

| Drive unit | Product line |
|------------|---|
| BDU3xx | Active Line, Active Line Plus, Performance Line |
| BDU4xx | Performance Line Speed, Cargo Line, Cargo Line Speed, Performance Line CX |

Setting up the Lock function

In order to be able to set up the lock function, the following conditions must be fulfilled:

- You have purchased the Lock function.
- The on-board computer is situated in the holder on the eBike.
- The on-board computer is connected to the smartphone via *Bluetooth*[®].
- The smartphone is connected to the Internet.

Go to the **<My eBike>** menu item in your eBike Connect app and set up the Lock function for your eBike by sliding the control **<Lock feature>** to the right.

From now on, you can deactivate the assistance from your drive unit by removing the on-board computer. The drive unit assistance can only be reactivated with the on-board computer that was used in the setup.

Even with the Lock function activated, you can continue to use your eBike without assistance from the drive unit.

How it works

In combination with the Lock function, the on-board computer functions similarly to a key for the drive unit. The Lock function is activated and deac-

tivated by respectively removing or inserting the on-board computer. The status of the Lock function is indicated by a padlock symbol that appears on the display of the on-board computer for approx. three seconds following its insertion.

Remove the on-board computer from its holder whenever you are away from the eBike so that the Lock function can fulfil its intended purpose.

If the on-board computer used in setting up the Lock function is not inserted on your eBike, the drive unit will not provide any assistance. However, you can still continue to use your eBike without assistance.

Note: The Lock function alone does not provide adequate theft protection; it is simply a supplement to a mechanical lock. The Lock function does not provide any form of mechanical lock for the eBike. Only the assistance from the drive unit is deactivated.

If you wish to give other users temporary or permanent access to your eBike, you will need to deactivate the Lock function in the eBike Connect app.

If you remove the on-board computer, the drive unit will emit a "Lock" sound (i.e. an audio signal that is played **once**) to indicate that the assistance from the drive unit is switched off.

Note: The audio signal will only be played if the system is switched on.

If you reinsert the on-board computer, the drive unit will emit two "Unlock" sounds (i.e. an audio signal that is played **twice**) to indicate that the assistance from the drive unit is enabled again.

The "Lock" sound will help you determine whether or not the Lock function on your eBike is active. The audio signal is activated by default, but it can be deactivated under **<My eBike>** by selecting the lock symbol below your eBike.

In the eBike Connect app, the Lock function under **<My eBike>** is indicated with a lock symbol next to the bikes.

Important: The lock symbol is only shown for eBikes that are suitable for the Lock function. Note the information in the section on compatibility.

Please contact your bike dealer if any of the following occurs:

- The Lock function can no longer be set up or switched off
- Your eBike Connect account has been deleted or deactivated, yet the Lock function has been set up and remains active.

Replacing eBike Components and the Lock Function

Replacing the Smartphone

1. Install the eBike Connect app on the new smartphone.
2. Log in with **the same** account that was used to activate the Lock function.
3. Connect your smartphone with the on-board computer while the on-board computer is attached.
4. The Lock function is displayed as set up and active in the eBike Connect app.

Replacing the on-board computer

1. Connect your smartphone with the on-board computer while the on-board computer is attached.
2. The Lock function is displayed as set up and active in the eBike Connect app.

Replacing the drive unit

1. The Lock function is displayed as set up and deactivated in the eBike Connect app.
2. Activate the Lock function by sliding the **Lock function** control to the right.

ABS – anti-lock braking system (optional)

If the eBike is fitted with a Bosch eBike ABS, the indicator light is shown in the display of the on-board computer during the system start-up as well as in the event of a fault. The indicator light goes out once the eBike is travelling faster than **6 km/h** and no fault has been detected by the ABS. If an ABS fault occurs while riding, the indicator light in the display will warn you that the ABS is inactive. If you acknowledge the fault, the text **<(ABS)>** will appear in place of the state of charge. You can continue to ride, yet will be reminded about the inactive status of the ABS.

For detailed information on the ABS and how it works, please refer to the ABS operating instructions.

eSuspension (optional)

eSuspension is the integration of electronic shock absorption and suspension elements into the eBike system. You can use the **Quick Menu** to select

predefined settings for the eSuspension system, provided that this type of system is fitted on your eBike.

When switching on the system or inserting the Kiox into the holder, you will briefly be shown which eSuspension mode is activated. The system is always started in the mode that was last active.

If you remove the Kiox, when the battery is empty or when you are travelling on reserve power for the lights, the suspension will be set to the soft mode.

For details of these settings, please refer to the operating instructions provided by the eSuspension manufacturer.

eSuspension is only available in combination with the Kiox on-board computer and can only be used with the BDU450 CX, BDU480 CX and BDU490P drive units.

eShift (optional)

eShift is the integration of electronic gear-shifting systems into the eBike system. The eShift components are electrically connected to the drive unit by the manufacturer. The separate operating instructions describe how to operate the electronic gear-shifting systems.

Powering external devices via the USB port

The USB port can be used to operate or charge most devices that can be powered via USB (e.g. various mobile phones).

Charging requires the on-board computer to be mounted and a sufficiently charged battery to be inserted in the eBike.

Open the protective cap **(17)** for the USB port on the on-board computer. Use a Micro-A – Micro-B USB charging cable (available from your Bosch eBike dealer) to connect the USB port on the external device to the USB port **(6)** on the on-board computer.

Once the electrical load has been disconnected, the USB port must be carefully resealed with the protective cap **(17)**.

USB connections are not waterproof. When cycling in the rain, do not connect any external devices and make sure that the USB port is fully sealed by the protective cover (17).

Important: If electrical loads are connected, this can affect the range of the eBike.

Displays and settings of the on-board computer

Please note: All screenshots showing the display and text on the following pages are from the approved software version. The display and/or text may change slightly following a software update.

Order of pages

Provided the on-board computer is fitted to the holder, you can view the following displays one after the other:

1. Start page
2. Time and range
3. Distance and journey time
4. Power and cadence
5. Average and maximum speed
6. Distance, range, power and heart rate
7. Heart rate
8. Calories burnt and total distance
9. Status page

Start page

When you insert the on-board computer into the holder while it is switched on, it will display the start page.

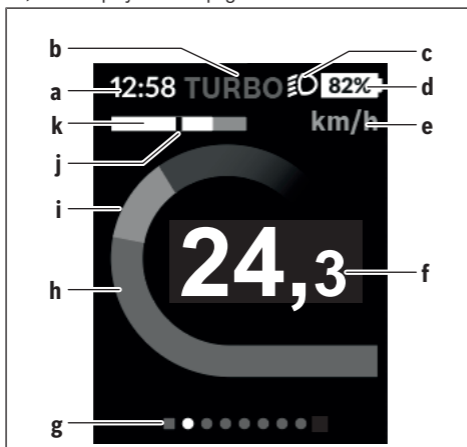

- a** Time/speed indicator
- b** Assistance level indicator
- c** Lighting indicator
- d** Battery charge indicator of the eBike battery
- e** Unit of speed indicator^{A)}
- f** Speed
- g** Navigation bar
- h** Motor output
- i** Your performance
- j** Average speed
- k** Performance evaluation

A) Can be changed via the **<Settings>** status page.

The **a** and **d** indicators form the status bar and are shown on every page. If the speed is already being displayed on the screen itself, the **a** indicator will change to the current time in hours and minutes. The status bar displays:

- **Speed/time:** The current speed in km/h or mph or the current time
- **Assistance level:** Indicates the current level of assistance using a colour code
- **Light:** A symbol that indicates whether the light is on
- **eBike battery state of charge:** Indicates the current state of charge as a percentage

The performance evaluation **k** graphically displays your current speed (white bar) in comparison to your average speed **j**. The graphic shows you whether your current speed is faster or slower than your average speed (left of the black line = lower than average value; right of the black line = higher than average value).

The navigation bar **g** indicates which page you are on. Your current page is highlighted. You can use the **< (10)** and **> (8)** buttons to move to additional pages.

From the initial start page, you can access the status page via the **< (10)** button.

Status screen

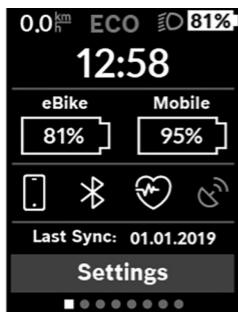

As well as the status bar, the status page also shows you the current time and the state of charge of all your eBike's batteries, as well as the state of charge of your smartphone battery if the smartphone is connected via *Bluetooth®*.

It may also display symbols to indicate an activated *Bluetooth®* function or a device connected via *Bluetooth®* (e.g. a heart-rate monitor). You will also be shown the date of the most recent synchronisation between the smartphone and Kiox.

You can access the **<Settings>** from the bottom section.

<Settings>

You can access the settings menu via the status page. The **<Settings>** cannot be accessed or changed while riding.

You can use the **- (11)** and **+ (12)** buttons to select the setting you want. You can open the settings, as well as any additional submenus, using the select button **(9)**. You can use the **<** button **(10)** to go back to the previous menu from any settings menu.

You can find the following superordinate sections on the first navigation level:

- **<Registration>** You can register here, if you have not yet done so via the app or the portal. This menu item is displayed only if you have not yet completed a registration.
- **<My eBike>** – Settings for your eBike

You can reset the counters (such as the number of kilometres travelled that day or average values) to zero either automatically or manually, and you can reset the range. You can change the wheel circumference value that was preset by the manufacturer by $\pm 5\%$. If your eBike features **eShift**, you can also configure your eShift system here. The bicycle dealer may base the service date on the distance travelled and/or on a period of time. The bike component page displays the serial number and hardware and software versions for each component in addition to other key data which is relevant for the components.

 - **<Reset>** Indicates when the last reset took place. The trip distance and average values can be reset.
 - **<Res. tr. dat. Aut. (Reset trip data automatically) [Current setting]>** Select from **<Off>**, **<Once a day>** or **<Aft inert 4h (After 4 hours of inactivity)>**
 - **<Reset range (Reset range calculation now)>** The value can be reset to the standard setting here.
 - **<eShift>** The cadence and starting gear can be set here.
 - **<Wheel circum. (Wheel circumference)>** The value of the wheel circumference can be adjusted or reset to the standard setting here.
 - **<Next Service: [DD. Mon. YYYY] or at [xxxxx] [km]>** only appears if a service date has been entered by the manufacturer or dealer.
 - **<eBike comps (My eBike components)>**

- **<Bluetooth>** – Switching the *Bluetooth*® function on or off:
Connected devices are displayed.
Go to **<Settings>** → **<Bluetooth>** to add a new device or remove a device that is no longer required.
Recommended heart-rate monitors:
 - Polar H7
 - Polar H10 Heart Rate Sensor
 - Runtastic Heart Rate Combo Monitor
 - Wahoo TICKR Heart Rate Monitor
 - BerryKing Heartbeat chest strap
 - BerryKing Sportbeat arm strap
 Other devices may also be compatible.
- **<Sys settings>**
You can display the speed and distance in kilometres or miles, display the clock in 12- or 24-hour format, adjust the time, date and time zone and select your preferred language. You can reset the Kiox to its factory settings, run a software update (if available) and choose between a black or white design.
- **<Information>**
 - **<Registration>**
 - **<FAQs>**
 - **<Intro to Kiox>**
 - **<Certifications>**
 - **<License info (License information)>**
 - **<Contact us>**

Quick Menu

Selected settings are displayed on the **Quick Menu**. These settings can be changed even while riding.

You can access the **Quick Menu** via the select button **(9)**. It cannot be accessed from the **Status screen**.

The following settings can be changed via the **Quick Menu**:

- **<Reset trip data?>**
All data on the journey so far is reset to zero.
- **<eShift>**
You can set the cadence here.

– **<eSuspension>**

This is where you can set a manufacturer-defined shock absorption or suspension mode.

Error code display

The eBike system's components are continuously and automatically monitored. If an error is detected, the corresponding error code is displayed on the on-board computer.

The drive may be automatically shut down, depending on the type of error. However, if you wish to continue cycling, you will always be able to do so without assistance from the drive. Before undertaking any other journeys, the eBike should be checked.

► **Have all repairs performed only by an authorised bike dealer.**

| Code | Cause | Corrective measures |
|------|--|---|
| 410 | One or more buttons of the on-board computer are disabled. | Check whether any buttons are stuck, e.g. as a result of dirt finding its way in. Clean the buttons if need be. |
| 414 | Operating unit connection problem | Have the connections checked |
| 418 | One or more buttons on the operating unit are disabled. | Check whether any buttons are stuck, e.g. as a result of dirt finding its way in. Clean the buttons if need be. |
| 419 | Configuration error | Restart the system. If the problem persists, contact your Bosch eBike dealer. |
| 422 | Drive unit connection problem | Have the connections checked |
| 423 | eBike battery connection problem | Have the connections checked |
| 424 | Communication problem between components | Have the connections checked |
| 426 | Internal time-out error | Restart the system. If the problem persists, contact your Bosch eBike dealer. With this error, it is not possible to bring up the wheel circumference in the basic settings menu or to adjust it. |
| 430 | Internal battery of the on-board computer is flat | Charge the on-board computer (in the holder or via the USB port) |

| Code | Cause | Corrective measures |
|------|---|---|
| | (does not apply to BUI350) | |
| 431 | Software version error | Restart the system. If the problem persists, contact your Bosch eBike dealer. |
| 440 | Internal drive unit fault | Restart the system. If the problem persists, contact your Bosch eBike dealer. |
| 450 | Internal software error | Restart the system. If the problem persists, contact your Bosch eBike dealer. |
| 460 | Error at USB port | Remove the cable from the USB port of the on-board computer. If the problem persists, contact your Bosch eBike dealer. |
| 490 | Internal fault of the on-board computer | Have the on-board computer checked |
| 500 | Internal drive unit fault | Restart the system. If the problem persists, contact your Bosch eBike dealer. |
| 502 | Bike light fault | Check the light and the associated wiring. Restart the system. If the problem persists, contact your Bosch eBike dealer. |
| 503 | Speed sensor fault | Restart the system. If the problem persists, contact your Bosch eBike dealer. |
| 504 | Speed signal distortion detected. | Check that the spoke magnet is positioned correctly, and adjust it if necessary. Check that nothing has been tampered with (tuning). Drive assistance is reduced. |
| 510 | Internal sensor fault | Restart the system. If the problem persists, contact your Bosch eBike dealer. |
| 511 | Internal drive unit fault | Restart the system. If the problem persists, contact your Bosch eBike dealer. |
| 530 | Battery fault | Switch off the eBike, remove the eBike battery and reinsert the eBike battery. |

| Code | Cause | Corrective measures |
|-------------|--|--|
| | | Restart the system. If the problem persists, contact your Bosch eBike dealer. |
| 531 | Configuration error | Restart the system. If the problem persists, contact your Bosch eBike dealer. |
| 540 | Temperature error | The eBike is outside of the permissible temperature range. Switch off the eBike system and allow the drive unit to either cool down or heat up to the permissible temperature range. Restart the system. If the problem persists, contact your Bosch eBike dealer. |
| 550 | An impermissible load has been detected. | Remove the load. Restart the system. If the problem persists, contact your Bosch eBike dealer. |
| 580 | Software version error | Restart the system. If the problem persists, contact your Bosch eBike dealer. |
| 591 | Authentication error | Switch off the eBike system. Remove the battery pack and reinsert it. Restart the system. If the problem persists, contact your Bosch eBike dealer. |
| 592 | Incompatible component | Use a compatible display. If the problem persists, contact your Bosch eBike dealer. |
| 593 | Configuration error | Restart the system. If the problem persists, contact your Bosch eBike dealer. |
| 595, 596 | Communication error | Check the wiring to the drive and restart the system. If the problem persists, contact your Bosch eBike dealer. |
| 602 | Internal battery fault | Restart the system. If the problem persists, contact your Bosch eBike dealer. |
| 603 | Internal battery fault | Restart the system. If the problem persists, contact your Bosch eBike dealer. |
| 605 | Battery temperature error | The battery is outside of the permissible temperature range. Switch off the eBike |

| Code | Cause | Corrective measures |
|------------|---|---|
| | | system and allow the battery to either cool down or heat up to the permissible temperature range. Restart the system. If the problem persists, contact your Bosch eBike dealer. |
| 606 | External battery fault | Check the wiring. Restart the system. If the problem persists, contact your Bosch eBike dealer. |
| 610 | Battery voltage error | Restart the system. If the problem persists, contact your Bosch eBike dealer. |
| 620 | Charger fault | Replace the charger. Contact your Bosch eBike dealer. |
| 640 | Internal battery fault | Restart the system. If the problem persists, contact your Bosch eBike dealer. |
| 655 | Multiple battery faults | Switch off the eBike system. Remove the battery pack and reinsert it. Restart the system. If the problem persists, contact your Bosch eBike dealer. |
| 656 | Software version error | Contact your Bosch eBike dealer so that they can perform a software update. |
| 7xx | Error relating to third-party components | Observe the information in the operating instructions of the respective component manufacturer. |
| 800 | Internal ABS fault | Contact your Bosch eBike dealer. |
| 810 | Implausible signals from the wheel speed sensor | Contact your Bosch eBike dealer. |
| 820 | Fault in the wire to the front wheel speed sensor | Contact your Bosch eBike dealer. |
| 821 to 826 | Implausible signals from the front wheel speed sensor | Restart the system and carry out a test ride lasting at least two minutes. The ABS indicator light must go out. If the problem persists, contact your Bosch eBike dealer. |

| Code | Cause | Corrective measures |
|-------------------------------------|---|---|
| | The sensor disc may be missing, defective or fitted incorrectly; there is a significant difference in diameter between the front wheel and the rear wheel; extreme riding situation, e.g. riding solely on the rear wheel | |
| 830 | Fault in the wire to the rear wheel speed sensor | Contact your Bosch eBike dealer. |
| 831 833 to 835 | Implausible signals from the rear wheel speed sensor The sensor disc may be missing, defective or fitted incorrectly; there is a significant difference in diameter between the front wheel and the rear wheel; extreme riding situation, e.g. riding solely on the rear wheel | Restart the system and carry out a test ride lasting at least two minutes. The ABS indicator light must go out. If the problem persists, contact your Bosch eBike dealer. |
| 840 | Internal ABS fault | Contact your Bosch eBike dealer. |
| 850 | Internal ABS fault | Contact your Bosch eBike dealer. |
| 860, 861 | Fault in the power supply | Restart the system. If the problem persists, contact your Bosch eBike dealer. |
| 870, 871 880 883 to 885 | Communication error | Restart the system. If the problem persists, contact your Bosch eBike dealer. |
| 889 | Internal ABS fault | Contact your Bosch eBike dealer. |

| Code | Cause | Corrective measures |
|------------|--|--|
| 890 | ABS indicator light is defective or missing; ABS may not be working. | Contact your Bosch eBike dealer. |
| No display | Internal fault of the on-board computer | Restart your eBike system by switching it off and back on. |

Displays and Settings of the Bosch eBike Connect Smartphone App

A smartphone is not included with the product. An Internet connection is required for registering with a smartphone. Depending on the contract, this can incur costs from your telephone provider. An Internet connection is also required for synchronising data between the smartphone and online portal.

Please note: All screenshots showing the display and text on the following pages are from the approved software version. Since a software update may be implemented over the course of the year, it is possible that the display and/or text of the interface may change.

The following description of the eBike Connect app applies to the Kiox (BUI330) and Nyon (BUI27x) on-board computers

Activating the Bosch eBike Connect Application

In order to be able to use all eBike Connect functions, it is necessary to have a smartphone with the **Bosch eBike Connect** application.

Proceed as follows to perform activation:

1. Open the Google Play store (Android) or the App Store (iOS) on your smartphone.
2. Search for **Bosch eBike Connect**.
3. Install the **Bosch eBike Connect** application and open it.
4. Register as described in the next section.











If you have already registered via the online portal (www.ebike-connect.com), you can also log in directly with your login data.

Registration via Smartphone

- Start the **Bosch eBike Connect** application.
- Select **<Sign up>**.
- Read and accept the terms and conditions and the privacy policy.
- After confirming these, an e-mail will be sent to the address you have specified with the provisions of the agreement.
- Activate your user account by clicking on the button in the e-mail you have received.

If the application **Bosch eBike Connect** is active and there is a *Bluetooth*[®] connection to your on-board computer, data between on-board computer and smartphone will sync automatically.

Main menu of Bosch eBike Connect

| Symbol | Menu item | Function |
|---|---------------------------|---|
|  | <Feed> | This menu item contains an overview of the number of kilometres that have been travelled over the last month, a display indicating the latest activity undertaken that has not yet been completed, and the latest news updates. |
|  | <Activities> | Under this menu item, you can view the trips you have made. |
|  | <Map> | You can plan and save routes via this menu item. Saved routes are automatically synchronised between the app and the on-board computer (does not apply to BUI330). |
|  | <My eBike> | Under this menu item, you can select your on-board computer and adjust your eBike settings. |
|  | <More> | Click this button to display additional menu items. |
|  | <Shop> | Under this menu item, you can purchase premium functions that are compatible with your product. |
|  | <Settings> | Under this menu item, you can view and edit your personal data, data protection settings and app settings, and also download maps for offline use of the app. |
|  | <Help> | This menu item contains <FAQs> , i.e. answers to frequently asked questions. |
|  | <Imprint> | This menu item contains contact details for the manufacturer. |
|  | <About> | This menu item contains information such as the current version of the app, the terms and conditions of use, the description of the service and the data protection notice. |

<Activities> menu item

Following successful synchronisation, your journeys will be shown on the map. The synchronisation status is displayed on the on-board computer.

When you select a journey, you will be shown the trip distance, the trip duration, the average speed, and also the route travelled on a map. In addition, three further pages with journey statistics such as the average cadence, the altitude travelled and additional data are available.

<Map> menu item

When you have selected this menu item, your current location will be shown using the GPS function of the smartphone.

Using the search function, you can select goals, saved routes or saved locations. It is also possible to input a destination by clicking on the map.

Once you have entered the destination, you will be offered three different routes (<Fast>, <Scenic> and <Mountain bike>) displaying the elevation profile.

- The <Fast> route shows you the fastest connection from your location to your selected destination while avoiding steeper slopes.
- The <Scenic> route shows you the most scenic connection from your location to your selected destination and avoids main roads.
- The <Mountain bike> route guides the cyclist over mostly unpaved trails and offers the best route for mountain bikers (not for eBikes up to 45 km/h).

Note: The different <Fast>, <Scenic> and <Mountain bike> routes may be identical on short routes.

Save the route for continued use.

If you are using the **Nyon**, this route will be automatically transmitted to the **Nyon** once a connection has been established between the app and the Nyon.

In addition to route planning, you will find your previously saved destinations and routes in the search history. Starting from your current location, you can also navigate home or to work.

<My eBike> menu item

When installing the app for the first time, a connection between the app and the on-board computer is established via this menu item.

To do this, select <Add new eBike device> and follow the instructions.

Following successful pairing, the currently connected on-board computer and the associated eBike components will be displayed.

The eBikes that have been connected with Kiox or Nyon are shown.

If the on-board computer has already been placed on at least two different eBikes, they are displayed here for selection. Otherwise, it is not possible to make a selection. The name assigned to each eBike can be changed, or an eBike can be deleted from the selection list.

Displays and settings of the online portal

Please note: All screenshots showing the display and text on the following pages are from the approved software version. Since a software update may be implemented over the course of the year, it is possible that the display and/or text of the interface may change.

The following description of the online portal applies to **Kiox** and **Nyon**

Online registration

Internet access is required for online registration.

- Use your browser to open the **Bosch eBike Connect** online portal at www.eBike-Connect.com.
- Read and accept the terms and conditions and the privacy policy.
- Follow the instructions and complete the registration.

Once you have registered, you can log in with your e-mail address and password from this point on. Alternatively, you can also log in via **Facebook login**. An existing Facebook profile is required for **Facebook login**. The login data of the online portal matches the login data of the **Bosch eBike Connect** smartphone application.

Online portal main menu

| Menu item | Function |
|--|--|
| <Dashboard> | Your most recent activities, statistical data, news and tips are displayed via this menu item. |
| <Route Planning> | You can plan new routes via this menu item. |
| <Activities> | Under this menu item, you can view the trips you have made. |
| <My eBike> | Under this menu item, you can manage your eBike components and create user-defined views. |
| <Help> | Under this menu item you will find the FAQ, contact details and other information. |
|  <My profile> | You can manage your profile via this menu item. |

<Route Planning> menu item

By specifying the start and end point, you can plan a new route. If required, you can add further intermediate destinations by entering the address.

Addresses or coordinates can be entered as a start and end point or intermediate destination. Alternatively, an element can be selected from the list of recent destinations, saved locations or points of interest.

In the map, you add further intermediate destinations by dragging a point from a route. By right-clicking, you can add a new end point or delete an existing point. The start and end point as well as the intermediate points on the map can be moved.

You can choose between three different routes (<Fast>, <Scenic> and <MTB>).

- The <Fast> route shows you the fastest connection from your location to your selected destination while avoiding steeper slopes.
- The <Scenic> route shows you the most scenic connection from your location to your selected destination and avoids main roads.
- The <MTB> route guides the cyclist over mostly unpaved trails and offers the best route for mountain bikers (**not applicable** to eBikes up to 45 km/h).

Note: The different **<Fast>**, **<Scenic>** and **<MTB>** routes may be identical on short routes.

The currently selected route is displayed on the map. In addition, the elevation profile, the distance and the estimated trip duration of the selected route are displayed.

Once you have set up your desired route, save it by clicking on **<Save>**.

The saved routes and locations are synchronised with the **eBike Connect** app once they have been saved.

If you are using the **Nyon**, this route will be automatically transmitted to the **Nyon** once a connection has been established between the app and the **Nyon**.

Importing the GPX track

GPX files contain a number of geographical coordinates (waypoints), which constitute a route according to their sequence. These GPX files can be used for navigation with the Nyon on-board computer (BUI27x). You can create or edit GPX files with the appropriate programs.

By clicking on the button **<Import GPX track>**, you can import GPX files up to 5 MB in size into the online portal. GPX files are transferred to Nyon as soon as Nyon is connected via the smartphone to the web over Wi-Fi or *Bluetooth*[®]. On its own, Nyon cannot import GPX files directly over a USB link.

The routability of GPX tracks depends on the accuracy of details on OSM maps. The following results are possible depending on the existence of roads and tracks which are navigable:

– **GPX track is completely routable**

The navigation system functions as usual, including turn-by-turn instructions and information regarding the remaining distance and estimated time of arrival. The turn-by-turn instructions can be switched off by pressing the button in the top right. If Nyon is close to the starting point, navigation can be started immediately. If Nyon is further away from the starting point, the rider can be navigated to that point.

– **GPX track cannot be routed**

The route is displayed statically on Nyon and can be travelled by the rider. No navigation details or time calculations can be made.

– **GPX track is partially routable**

If you use the changed version, you can convert and save the route into a fully routable track. If you have the original version, the route is treated as a non-routable track.

<Activities> menu item

In the overview, you can see a summary of all the activities you have recorded to date. You can also choose to display activities for a specific time period. Under the **<Activities>** menu item, you can see individual activities in detail.

Following successful synchronisation, your journeys will be shown on the map. The synchronisation status is displayed on the on-board computer.

If you select a journey, additional statistical data will be provided alongside the route length and journey duration. The route travelled will be displayed on a map. You can display up to two journey-related parameters in the form of a diagram.

If you use a chest strap, your heart rate is also displayed.

Activities which are not complete are also displayed following synchronisation.

Under **<Options>**, you have the option to export the completed activity or to convert the activity into a route.

If you have linked your account with Facebook, you can share the completed activity with your friends on Facebook.

<My eBike> menu item

Under **<My eBike>**, you can manage your eBike components, create and adapt user-defined views and individual riding modes (only applies to Nyon BUI27x).

<Help> menu item

In the **<Help>** menu item, you will find a selection of FAQs (frequently asked questions), contact details, legal information and information about the system and licences.

<My profile> menu item

Under **<My profile>**, you can edit your profile:

- Under **<My profile>**, you can change your e-mail address and password as well as edit your fitness data or personal data.

- You can also select your preferred language for the portal interface from nine different languages.
- You can delete your account on **eBike Connect**.

Maintenance and servicing

Maintenance and cleaning

Do not clean any of the components with pressurised water.

Keep the screen of your on-board computer clean. Dirt can cause faulty brightness detection.

Clean your on-board computer using a soft cloth dampened only with water. Do not use cleaning products of any kind.

Have your eBike system checked by an expert at least once a year (including mechanical parts, up-to-dateness of system software).

In addition, the bicycle dealer may base the service date on the distance travelled and/or on a period of time. In this case, the on-board computer displays a message telling you when the service date is due each time it is switched on.

Please have your eBike serviced and repaired by an authorised bicycle dealer.

► **Have all repairs performed only by an authorised bike dealer.**

After-sales service and advice on using products

If you have any questions about the eBike system and its components, contact an authorised bicycle dealer.

For contact details of authorised bike dealerships, please visit www.bosch-ebike.com.

Transport

► **If you transport your eBike attached to the outside of your car, e.g. on a bike rack, remove the on-board computer and the eBike battery to avoid damaging them.**

Disposal



The drive unit, on-board computer incl. operating unit, battery, speed sensor, accessories and packaging should be disposed of in an environmentally correct manner.

Do not dispose of eBikes and their components with household waste.



In accordance with Directive 2012/19/EU and Directive 2006/66/EC respectively, electronic devices that are no longer usable and defective/drained batteries must be collected separately and recycled in an environmentally friendly manner.

Please return Bosch eBike components that are no longer usable to an authorised bicycle dealer.

Subject to change without notice.

Robert Bosch GmbH

72757 Reutlingen

Germany

www.bosch-ebike.com

1 270 020 Ken (2019.11) T / 50