



Nyon operating instructions

Online version

en Original instructions



Table of Contents

Safety Notes	5
General Safety Rules	5
Safety Warnings for eBikes	6
Safety information relating to the navigation system	7
Congratulations	8
Updates	8
First steps	9
The “Nyon” operating system	11
Premium features	12
Smartphone compatibility	13
Operating logic	14
Main Menu	15
Initial Operation	16
Requirements	16
Switching the eBike System On/Off	16
Inserting and removing the on-board computer	17
Switching on/shutting down the on-board computer	17
Power Supply of External Devices via USB Connection	18
Initial Operation of the On-board Computer	18
Registration at the On-board Computer	19
Connecting a heart rate monitor to Nyon	20

Operation	21
Displays and configurations of the on-board computer	21
Operating mode “Dashboard”	21
Operating mode “Ride”	22
Operating mode “Map&Navigation”	23
Operating mode “Fitness”	27
Operating mode “Settings”	29
Status display	31
Energy supply of the on-board computer	32
Resetting Nyon	32
Battery Charge-control Indicator	33
Setting the Assistance Level	34
Switching the Push-assistance mode On/Off	36
Switching bike lights on/off	36
eShift (optional)	37
eShift with NuVinci H Sync	37
eShift with SRAM DD3 Pulse	38
eShift with Shimano Di2	38
Displays and settings of the smartphone application	
“Bosch eBike Connect”	39
Activating the application “Bosch eBike Connect”	40
Registration via smartphone and Bluetooth® connection	41
Main menu of “Bosch eBike Connect”	42
Menu item “Dashboard”	43
Menu item “Activities”	44
Menu item “Map”	45
Menu item “Shop”	46
Menu item “Settings”	46
Transferring the maps to Nyon	48

Menu item “Help”	49
Displays and settings of the online portal	50
Online registration	50
Online portal main menu	51
Menu item “Dashboard”	51
Menu item “Activities”	52
Menu item “Map”	53
Import GPX data	54
Menu item “Settings”	54
Device Information	55
Technical Data	55
Error Code Indication	56
Maintenance and Cleaning	60
After-sales Service and Application Service	61
Transport	61
Disposal	62

Safety Notes

General Safety Rules



Read all safety warnings and all instructions. Failure to follow the warnings and instructions may result in electric shock, fire and/or serious injury.

Save all safety warnings and instructions for future reference.

The term “battery pack” used in these operating instructions, irrespective of model, refers both to standard battery packs (battery packs with holder on the bike frame) and to rack-type battery packs (battery packs with holder in the rear rack/carrier).

- ▶ **Make sure to not be distracted by the display of the on-board computer.** If you do not focus exclusively on the traffic, you risk being involved in an accident. If you want to make entries in your on-board computer other than switching the assistance level, stop and enter the appropriate data.
- ▶ **Before beginning any exercise program, seek advice from a doctor about which pressure you can place yourself under.** This is the only way to avoid potential overloading.
- ▶ **When using a heart rate monitor the heart rate displayed may be distorted by electromagnetic interference.** The heart rates displayed are for reference only. No liability can be accepted for consequences caused by incorrectly displayed heart rates.

Safety Warnings for eBikes

- ▶ **Do not open the drive unit yourself. The drive unit must be repaired only by qualified experts and only with original spare parts.** This will ensure that the safety of the drive unit is maintained. Unauthorised opening of the drive unit will void warranty claims.
- ▶ **Do not open Nyon.** Opening Nyon can destroy it and void any warranty claims.
- ▶ **All components mounted to the drive unit and all other components of the eBike drive (e.g., the chainwheel, chainwheel seat, pedals) may be replaced only with identical components or components specifically approved for your eBike by the bicycle manufacturer.** This protects the drive unit against overload and damage.
- ▶ **Remove the battery pack from the eBike before beginning work (e.g. inspection, repair, assembly, maintenance, work on the chain, etc.) on the eBike, transporting it by car or plane, or storing it.** Unintentional activation of the eBike system poses a risk of injury.
- ▶ **The eBike system can switch itself on when the eBike is pushed backwards.**
- ▶ **The push/start aid feature may only be used when pushing or starting the eBike.** There is danger of injury if the wheels of the eBike do not have ground contact while using the push/start aid feature.
- ▶ **Use only original Bosch battery packs approved for your eBike by the manufacturer.** Using other battery packs can lead to injuries and pose a fire hazard. When using other battery packs, Bosch shall not assume any liability and warranty.
- ▶ **Do not make any modifications to your eBike system or fit any other products which would be suitable for increasing the performance of your eBike system.** This normally reduces the lifetime of the system and risks damage to the drive unit and the bike. There is also a risk of losing the guarantee and warranty claims on the bike you have purchased. By handling the system improperly you are also endangering your safety and that of other road users, thus running the risk of high personal liability costs and possibly even criminal prosecution in the event of accidents attributable to manipulation.

- ▶ **Please observe all national regulations on registering and using eBikes.**
- ▶ **Do not use the on-board computer as a handle.** Lifting the eBike up by the on-board computer can cause irreparable damage to the on-board computer.
- ▶ **Nyon is not a medical product.** The values displayed in the “Fitness” operating mode may differ from the actual values.
- ▶ **Use the Nyon on-board computer only with the associated operating unit, which has its own joystick.** The joystick on the operating unit has the same range of functions as the joystick on the on-board computer itself.
- ▶ **Read and observe the safety warnings and instructions in all operating instructions of the eBike system and in the operating instructions of your eBike.**

Safety information relating to the navigation system

- ▶ **Do not plan your routes whilst you are cycling. Stop and wait until you are stationary before entering a new destination.** If you do not focus exclusively on the traffic, you risk being involved in an accident.
- ▶ **Abandon your route if the navigation system suggests a path or road which is too ambitious, risky or dangerous for you based on your cycling ability.** Have your navigation system propose an alternative route.
- ▶ **Do not ignore any road signs, even if the navigation system tells you to take a specific route.** The navigation system cannot take roadworks or temporary diversions into account.
- ▶ **Do not use the navigation system in situations which are safety-critical or unclear (road closures, diversions, etc.).** Always carry extra maps and means of communication with you.

Congratulations

Congratulations on purchasing the first all-in-one eBike computer.

Nyon is an eBike controller, navi and fitness trainer in one and also performs smartphone functions.

- First all-in-one eBike on-board computer with separate operating unit
- eBike, navigation, fitness and internet functions
- Bike-optimised navi with moving map in 2D and 3D
- Bluetooth® connection to a heart rate monitor possible
- Wi-fi link to portal **“Bosch eBike Connect”**

Updates

The Nyon's range of functions is continually being expanded. Keep your **“Bosch eBike Connect”** smartphone application up to date. You can use this application to download new functions and transfer them to your Nyon.

First steps



- 1 Joystick
- 2 Button **"Home"**
- 3 On-board computer
- 4 Holder for on-board computer
- 5 On/Off button for on-board computer
- 6 Bike lights button
- 7 Brightness sensor
- 8 USB port
- 9 Protective cap of USB port

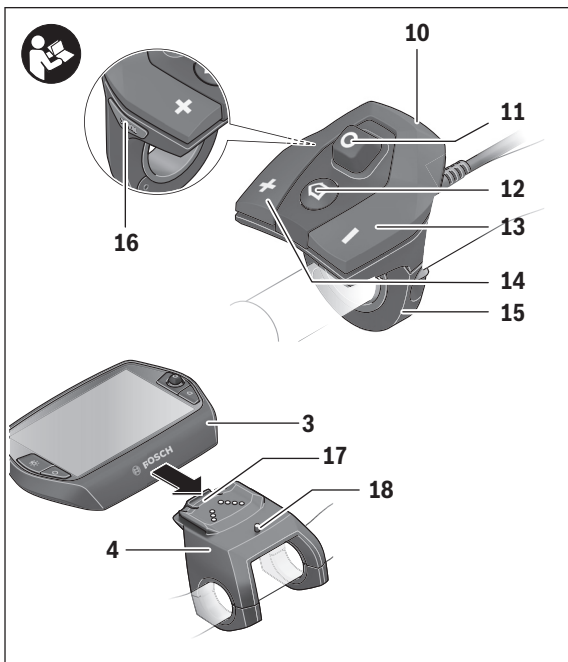

- 10** Operating unit
- 11** Joystick on the operating unit
- 12** **“Home”** button on the operating unit
- 13** Decrease assistance level button
- 14** Increase assistance level button
- 15** Holder for operating unit
- 16** Button push/start aid **“WALK”**
- 17** Lock latch for on-board computer
- 18** Locking screw for on-board computer

The “Nyon” operating system

The Nyon operating system consists of three components:

- the Nyon on-board computer with operating unit
- the smartphone application “**Bosch eBike Connect**”
- the online portal “**www.eBike-Connect.com**”



Standard functions and display	Advanced functions	Data collection and evaluation
Login on Nyon	Registration in online portal	Registration in online portal
Operation of eBike	User-defined settings	User-defined settings
Recording and visualisation of journey data	Purchasing and downloading premium features	Import and evaluation of routes travelled
Navigation	Convenient route planning	Advanced display with statistics
		Convenient route planning

Many configurations and features can be managed and used on all components. Some configurations and features can be accessed or operated only via certain components. The synchronization of data occurs automatically during Bluetooth®-/internet connection. The following table provides an overview of the available features.

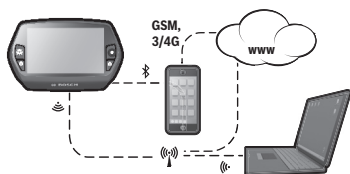

	On-board computer	Smartphone application	Online portal
Log in/registration	✓	✓	✓
Change of configurations	✓	✓	✓
Recording of journey data	✓		
Real-time display of journey data	✓		
Processing/analysis of journey data		✓	✓
Creating user-defined displays		✓	✓
Displays the current location*	✓	✓	✓
Navigation	✓		
Route planning	✓	✓	✓
Display of remaining distance (circle around the current location)	✓	✓	
Training effect in real-time	✓		
Overview of journeys		✓	✓
Statistics “Dashboard”	✓	✓	✓
Purchase of “premium features”		✓	

*GPS required

Premium features

The standard features of the “Nyon” operating system can be expanded via the App Store for Apple iPhones and Google Play Store for Android devices through the purchase of “premium features”.

In addition to the free **“Bosch eBike Connect”** application, fee-based premium features are available.

- User-related adaptation of the assistance levels
- “Topo operating range” (for displaying the battery’s remaining range, taking into consideration the geographical conditions)

Smartphone compatibility

A smartphone is not included in the delivery. To register with the smartphone internet connection is required, which, depending on the contract, can generate costs at your telephone provider. For the synchronization of data between the smartphone and online portal an Internet connection is also required.

To make use of the full range of functions provided by your on-board computer, you need a smartphone with the Android operating system, version 4.0.3 or a later version, or iOS 8 or a later version.

Compatible smartphones are listed in the table below.

Manufacturer	Compatible smartphones	Operating system
Apple	iPhone 5, 5S, 5C, 6, 6+, 6S, 6S+	iOS ≥8
Apple	iPod Touch (5th Generation)	iOS ≥8
Google	Nexus 4	Android ≥4.0.3
HTC	Desire X	Android ≥4.0.3
HTC	One	Android ≥4.0.3
HTC	One X	Android ≥4.0.3
Huawei	Ascend P2	Android ≥4.0.3
LG	Optimus L7	Android ≥4.0.3
Motorola	Razr HD	Android ≥4.0.3
Samsung	Galaxy S3	Android ≥4.0.3
Samsung	Galaxy S3 mini	Android ≥4.0.3
Samsung	Galaxy S4, S5, S6	Android ≥4.0.3
Sony	Xperia arc S	Android ≥4.0.3
Sony	Xperia Z	Android ≥4.0.3

Smartphones with the above mentioned operating systems, which are not included in the list can be connected under certain circumstances with the on-board computer. However, a complete compatibility of the on-board computer with the smartphones not listed, can not be guaranteed.

Download the application **“Bosch eBike Connect”** to your smartphone from the App Store for Apple iPhones and Google Play Store for Android devices.

Operating logic

A change in the display can be achieved during the trip via the operating unit **10**. This way both hands can stay on the handlebars while cycling.

With the control elements on the on-board computer, you have the following options:

- Switch the on-board computer on or off using the On/Off button **5**.
- The default mode of operation in **“Settings”** > **“My Nyon”** can be reached via the **“Home”** (**2** or **12**) button.
- The bike lights can be switched on or off using the bike light button **6**.
- Use the joystick **1** to navigate through the respective operating modes. Make a selection by pressing the joystick **1**.

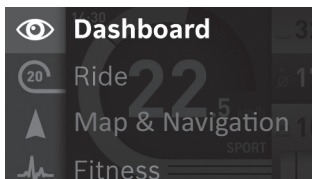





Press left on the joystick **1** to overlay the active operating mode with the main menu and to switch it to the main menu (see picture above).

If you press the joystick **1** right while in the active operating mode, the current screen is overlaid with the potential configuration options of the current operating mode. Move the joystick to the desired option and select it by pressing the joystick **1**.

Tip: If you are in an active operating mode, you can switch directly to the next operating mode by pressing the joystick **1** up or down.

If Nyon is on the eBike, **“Ride”** is displayed after switching on the operating mode. If Nyon is not mounted on the eBike, **“Dashboard”** is displayed on the operating mode.

Main Menu

Symbol	Operating mode	Function
	“Dashboard”	This operating mode displays various pieces of statistical data, the connection status and the synchronisation status.
	“Ride”	This operating mode provides current journey data.
	“Map & Navigation”	Use this operating mode to download map data based on Open Street Map (OSM) over the web. You can navigate using these maps.
	“Fitness”	Via this mode you can view various fitness-related information.
	“Settings”	This operating mode allows you to set the basic configurations of your on-board computer.

Initial Operation

Requirements

The eBike system can only be activated when the following requirements are met:

- A sufficiently charged eBike battery pack is inserted (see operating instructions of the battery pack).
- The on-board computer is properly inserted in the holder (see “Inserting and removing the on-board computer”, page English – 17).

Switching the eBike System On/Off

Options for **switching on** the eBike system:

- Place the on-board computer into the holder **4**.
- When the on-board computer and the eBike battery pack are inserted, briefly press the On/Off button **5** of the on-board computer.
- When the on-board computer is inserted, press the On/Off button of the eBike battery pack (see battery pack operating instructions).

The drive is activated as soon as you step on the pedals (except for in the push assistance function or in assistance level “**OFF**”). The motor output depends on the settings of the assistance level on the on-board computer.

As soon as you stop pedaling when in normal operation, or as soon as you have reached a speed of 25/45 km/h, the assistance from the eBike drive is switched off. The drive is automatically re-activated as soon you start pedaling again and the speed is below 25/45 km/h.

Options for **switching off** the eBike system:

- Press the On/Off button **5** of the on-board computer for at least 1 second.
- Switch the eBike battery pack off by its On/Off button (see battery pack operating instructions).
- Remove the on-board computer out of its holder.

If no power is drawn from the drive for about 10 minutes (e.g. because the eBike is not moving) or no button is pressed on the Nyon, the eBike system will shut down automatically to save energy.

Inserting and removing the on-board computer

To **insert** the on-board computer **3**, slide it from the front into the holder **4**.

To **remove** the on-board computer **3**, press the lock latch **17** and slide the on-board computer toward the front out of the holder **4**.

► Remove the on-board computer when you park the eBike.

It is possible to secure the on-board computer against removal in the holder. To do so, remove the holder **4** from the handlebar. Put the on-board computer in the holder. Screw the locking screw **18** (thread M3, 8 mm long) from below into the thread provided in the holder. Mount the holder back onto the handlebar.

Switching on/shutting down the on-board computer

To **switch on** the on-board computer briefly press the On/Off button **5**.

To **shut down** the on-board computer press the On/Off button **5** for at least 1 second.

If no button is pressed after 5 minutes, Nyon goes into power saving mode (back lighting off) and shuts down automatically after a further 5 minutes.

Power Supply of External Devices via USB Connection

With the USB connection, it is possible to operate and charge most devices whose power supply is possible via USB (e.g., various mobile phones).

Prerequisite for charging is that the on-board computer and a sufficiently charged battery pack are inserted in the eBike.

Open the protective cap **9** of the USB port on the on-board computer. Connect the USB connection of the external device to the USB port **8** on the on-board computer using the USB charging cable Micro A – Micro B (available from your Bosch eBike dealer).

Once the consumer has been disconnected, the USB connection must be sealed again carefully with the protective cap **9**.

► **USB connections are not a waterproof. When cycling in the rain, do not connect any external devices and make sure that the USB port is fully covered by the protective cap 9.**

Attention: Users connected to Nyon can affect the range of the eBike.

Initial Operation of the On-board Computer

The battery pack is supplied partially charged. Before the first use, the Nyon battery pack must be fully charged via the USB port (see “Energy supply of the on-board computer”, page English – 32) or the eBike system.

In order to use all the features of the operating system, you must also register online.

Registration at the On-board Computer

- Switch on the on-board computer using the On/Off button **5**.
- Use the joystick **1** to select your preferred language (select by pressing the joystick) and follow the instructions.

You have the following options to put Nyon into operation:

- **“TEST RIDE”**

You can perform a test ride without having to register in advance or to enter data. After shutting down, all trip data will be deleted.

- **“SET UP”>“OFFLINE”**

This is a very short registration process limited to Nyon. Offline means in this case that your journey and user data are only saved locally on the on-board computer.

Follow the instructions and choose one of the suggested answers.

Entered data is kept after shutting Nyon down, but will not be synced to the online portal or smartphone application.

If you subsequently undergo the complete registration process, the data collected up to that point is deleted, i.e. it is not synchronised with the online portal or the smartphone application either.

- **“SET UP”>“ONLINE”>“PHONE”**

This is a complete registration process. Insert Nyon in the holder **4**, download the application **“Bosch eBike Connect”** to your smartphone and register using the application. Following registration, the journey data are stored and synchronized with the smartphone application and the online portal.

- **“REGISTR.”>“ONLINE”>“WI-FI”**

This is a complete registration process. Go to an access point of a wi-fi network. Place your Nyon in the holder **4**. After selecting a network and entering your ID and password, Nyon then connects to the WLAN network of your choice and you are directed to the

“www.eBike-Connect.com” online portal where you can register.

Following registration, the journey data are stored and synchronized with the online portal. You can then connect your Nyon to your smartphone (**“Settings”>“Connections”>“Connect Smartphone”**).

Connecting a heart rate monitor to Nyon

A heart rate monitor is not included in the delivery.

To check your heart rate, you can use a heart rate monitor, which you can connect to Nyon via Bluetooth®.

Connect the heart rate monitor to your Nyon in the **“Settings”** menu under **“Connections”** using the **“Heart Rate Monitor”** menu item. When the menu item has been selected, your Nyon will automatically search for a device. When Nyon has found your heart rate monitor, select it and follow the instructions.

► **Please also observe the instructions in the owner’s manual from your heart rate monitor manufacturer.**

The compatible heart rate monitors are listed in the table below.

Manufacturer	Compatible heart rate monitors
Polar	H7

Operation

Displays and configurations of the on-board computer

Operating mode “Dashboard”

This operating mode displays various pieces of statistical data, the connection status and the synchronisation status.

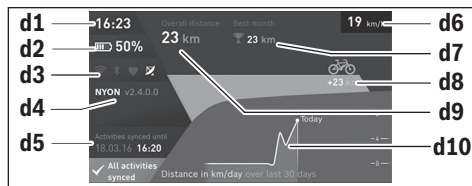

- d1** Clock
- d2** Charge level indicator of the eBike battery pack
- d3** Connection status
- d4** Nyon version information
- d5** Nyon synchronisation information
- d6** Speed/light status display (when the on-board computer is fitted)
- d6** Charge level indicator of the on-board computer battery (when the on-board computer is removed)
- d7** Highest number of kilometres travelled in a month
- d8** Kilometres travelled in comparison to the previous month
- d9** Total kilometres
- d10** Daily kilometres travelled in the last 30 days

Pushing the joystick **1** to the right allows the changes made in the portal or in your app to be synchronised with the Nyon. To do so, select the  button.

The following are synchronised:

- Saved routes and locations
- User-defined screens and riding modes
- User settings

Synchronisation is performed via WLAN or Bluetooth®. If both connection types are deactivated, you will receive a corresponding fault message.



Operating mode “Ride”

This operating mode provides current journey data.



- r1 Clock
- r2 Own pedal power
- r3 Speed
- r4 Engine power
- r5 Assistance-level indicator
- r6 Shift recommendation/eShift displays
- r7 Trip meter
- r8 Average speed
- r9 Coverage
- r10 Charge level indicator of the eBike battery pack

Pressing the joystick **1** to the right enables you to choose from the following options:

- **“Custom Modes”** (Custom Riding Modes)
This option is a premium feature which can be activated by purchasing it. The settings of the configuration data are made using the **“Bosch eBike Connect”** application on a smartphone (see Menu item “Settings”, page English – 46). You can also enter settings for configuration data in the online portal.
- **“Custom Screen”**
The settings of the configuration data are made using the **“Bosch eBike Connect”** application on a smartphone (see Menu item “Settings”, page English – 46). You can also enter settings for configuration data in the online portal.
- **“Reset Trip”**
This option can be used to reset the trip meter, calories burned and all average values to **“0”**.



Operating mode “Map & Navigation”

- ▶ **Make sure to not be distracted by the display of the on-board computer.** If you do not focus exclusively on the traffic, you risk being involved in an accident. If you want to make entries in your on-board computer other than switching the assistance level, stop and enter the appropriate data.
- ▶ **Do not plan your routes whilst you are cycling. Stop and wait until you are stationary before entering a new destination.** If you do not focus exclusively on the traffic, you risk being involved in an accident.
- ▶ **Abandon your route if the navigation system suggests a path or road which is too ambitious, risky or dangerous for you based on your cycling ability.** Have your navigation system propose an alternative route.
- ▶ **Do not ignore any road signs, even if the navigation system tells you to take a specific route.** The navigation system cannot take roadworks or temporary diversions into account.
- ▶ **Do not use the navigation system in situations which are safety-critical or unclear (road closures, diversions, etc.).** Always carry extra maps and means of communication with you.

Use this operating mode to download map data based on Open Street Map (OSM) over the web. You can navigate using these maps.

The map material suitable for the place of residence is installed by the bike dealer for the respective buyer. If required, additional maps can be downloaded via your smartphone application “**Bosch eBike Connect**” and be transferred to your on-board computer.

If you have an active WLAN connection, it is possible to load any maps directly onto Nyon via “**Settings**” > “**Map & Navigation**” > “**Map Manager**”.

When you switch on Nyon, it begins the satellite search to receive GPS signals. Once a sufficient number of satellite signals is found, the operating mode displays **“Map & Navigation”** on the map with the current location. In case of unfavourable weather conditions or locations, the satellite search may take a little longer. If the application fails to find satellites over a long period of time, restart Nyon.

Pressing the joystick **1** to the right enables you to choose from the following options:

– **“Navigate”**

You can use the **“Enter Destination”** menu item to enter the destination address. To do so, use the joystick to select the letters from the list and confirm each selection by pressing the joystick. Once you have entered the destination, you will be offered three different routes (**“Short/MTB”**, **“Scenic”** and **“Fast”**) displaying the elevation profile. The **“Short”** route shows you the shortest way from your location to your selected destination (**only** for eBikes up to 45 km/h).

The **“MTB”** route guides the cyclist over mostly unpaved trails and offers the best route for mountain bikers (**not** for eBikes up to 45 km/h). The **“Scenic”** route shows you the most scenic connection from your location to your selected destination and avoids main roads.

The **“Fast”** route shows you the fastest connection from your location to your selected destination while avoiding steeper slopes.

The different **“Short/MTB”**, **“Scenic”** and **“Fast”** routes may be identical on short routes.

Navigation will start once you have selected your preferred route. Route planning can also be performed using the **“Bosch eBike Connect”** application and in the online portal.

Alternatively, you can opt to be guided home, select one of the last destinations used, or choose from saved locations and routes.

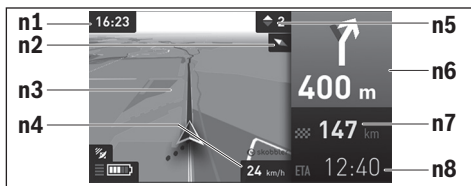

- n1** Clock
- n2** Compass needle
- n3** Map
- n4** Speed
- n5** Shift recommendation
- n6** Turn instructions and distance to the next turn
- n7** Distance to destination
- n8** Estimated time of arrival at destination

– “Battery Range”

This option enables you to view the battery range as a circle on the map.

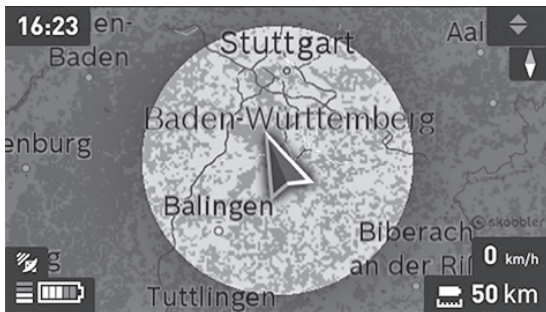

The basic remaining range of the battery can be extended by means of the “Topo operating range” premium feature. The “Topo operating range” feature then calculates and displays the battery’s remaining range, taking into consideration the topographical conditions.



– “Zoom Out/Zoom In”

You can use this option to change the level of zoom. The zoom settings for the map section can also be changed by (repeatedly) pressing the joystick.

During the navigation, the guidance (e.g. turn left in 50 meters) will also be displayed via a cross fade in other operating modes.

If you interrupt a journey for which you are using navigation and then call up **“Map & Navigation”**, you will be asked whether or not you wish to continue navigation. If you continue navigation, the navigation system will guide you to your last destination.

If you have imported GPX routes via the online portal, these will be transferred to your Nyon via Bluetooth® or via a WLAN connection. You can start these routes when you wish. If you are near a route, you can have the navigation system guide you to the starting point or you can start navigating along the route immediately.

You can enter up to eight intermediate destinations for a trip.

If you are using intermediate destinations, a message will inform you when you have reached an intermediate destination. Your nearest **“Bosch eBike experts”** are also shown under **“Points of Interest”**. When you select a dealer, the route to it will be calculated and made available for you to select.

Nyon is not suitable for a navigation without a bicycle (for hikers or motorists).

At temperatures below 0 °C, the altitude measurement is likely to deviate significantly.



Operating mode “Fitness”

Via this mode you can view various fitness-related information.

Based on the activity level provided in your registration, the effect of your activities will be displayed on your stamina level (training effect).

The training effect is calculated from pedal power and the duration of an eBike journey. The calculation accounts for the age, body size, weight and activity level of the rider.

This enables the rider to be warned of possible overexertion in relation to his/her fitness level. For example, an unfit eBike rider may be notified of possible overexertion after only 30 minutes, whereas a very fit rider will not be notified at all if subjected to the same strain or may only be notified after 2 hours if subjected to very heavy strain.



- f1** Clock
- f2** Current performance/heart rate*
- f3** Display of the current training effect
- f4** Training effect
- f5** Kilocalories burned
- f6** Current cadence
- f7** Current speed
- f8** Duration

***When using a chest strap to measure the heart rate (not included in the delivery), your current heart rate will be displayed instead of the performance.**

Pressing the joystick **1** to the right enables you to choose from the following options:

– **“Custom Screen”**

The settings of the configuration data are made using the **“Bosch eBike Connect”** application on a smartphone or via the online portal.

– **“Reset Trip”**

This option can be used to reset the trip meter, calories burned and all average values to **“0”**.



Operating mode “Settings”

This operating mode allows you to set the basic configurations of your on-board computer.

Note: Some basic configurations can only be changed when Nyon is inserted into the holder **4**.

To reach the “**Settings**” menu, press the joystick **1** down in the main menu until “**Settings**” is displayed.

Tip: If you press the joystick down long enough, you will also reach the “**Settings**” menu.

The following configurations can be made:

- “**Connections**”: You can configure the Bluetooth® settings, a new smartphone connection, a WiFi connection or a heart rate monitor. When you enable WiFi, Nyon searches for available networks. Found networks will be displayed. Use the joystick **1** to select the desired network and enter the password.
- “**Map & Navigation**”: Here under “**Map Style**” you can select the display mode (2D or 3D) for “**Map Mode**” and “**Navigation**” and turn on automatic adaptation of the map display depending on the ambient brightness.
Under “**Map Manager**”, you can manage the maps installed on your Nyon, e.g. delete maps which are no longer required to free up storage space.
Under “**Auto Day/Night**”, you can automatically change the map display depending on the ambient brightness.

- **“My Profile”**: Here you can also choose to display the active user.
- **“My eBike”**: When Nyon is plugged in, you can change the pre-set value given by the manufacturer of the wheel circumference by $\pm 5\%$.
The bicycle manufacturer or dealer may base the service date on the distance travelled and/or a period of time. The due date for the service is displayed under **“Service”**.
Under **“Shift Recommendation”**, you can switch the indication of a shift recommendation on and off.
If your eBike is equipped with **“eShift”**, you can also configure your eShift system here (see “eShift (optional)”, page English – 37).
- **“My Nyon”**: Here you can search for updates, configure the Home button, automatically set the counters such as trip meter, calories burned and average values to “0” every night, or reset Nyon to the factory settings.
Under **“Auto Brightness”**, the brightness of the display can be automatically adjusted.
Under **“Altitude correction”**, you can adjust the value displayed to the actual altitude to compensate for weather-related changes.
- **“Region & Language”**: You can set speed and distance in kilometres or miles, display clock in 12 or 24 hour format, select the time zone and set your preferred language. The current time is automatically taken from the GPS signal.
- In the **“Help”** menu item, you will find a selection of FAQs (frequently asked questions), contact details and information about the system and licenses.

Status display

You are shown status indicators in addition to the displays of your current operating mode.

Depending on the operating mode shown, all status indicators are not always displayed. Indicators already shown on the main screen will not be shown again. The position of the indicators may vary. If the on-board computer is taken out of its holder, the charging state of the Nyon battery of the on-board computer is displayed in place of the bike lights indicator.

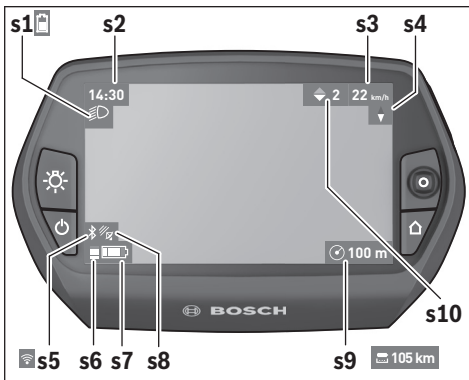

- s1** Bike lights indicator/Charge level indicator of Nyon battery pack
- s2** Clock display
- s3** Speed display
- s4** North display
- s5** Bluetooth®/WiFi connection display
- s6** Assistance level display
- s7** Charge level indicator of the eBike battery pack
- s8** GPS signal display
- s9** Zoom range/remaining range display
- s10** Shift recommendation

Energy supply of the on-board computer

If the on-board computer is in the holder **4**, a sufficiently charged eBike battery pack is inserted into the eBike and the eBike system is turned on, then the Nyon battery pack is powered by the eBike battery pack.

If the on-board computer is removed from the holder **4**, the energy is supplied via the Nyon battery pack. If the Nyon battery pack is weak, a warning message appears on the display.

To charge the Nyon battery pack, insert the on-board computer back into the holder **4**. Note that if you do not charge the eBike battery pack straight away, the eBike system will automatically switch off after 10 minutes of inactivity. In this case, the charging of the Nyon battery pack will also cease.

You can also charge the on-board computer via the USB port. Open the protective cap **9**. Connect the USB port **8** of the on-board computer via a micro USB cable with a standard USB charger (not included in the delivery) or the USB port of a computer (5 V charging voltage, max 500 mA charging current).

Note: If Nyon is shut down during charging, Nyon can only be switched on again if the USB cable has been disconnected (applies to 1 270 020 907 only).

If the on-board computer is removed from the holder **4**, all values of the features are saved and can still be displayed.

Without recharging the Nyon battery pack, date and time will remain up to a maximum of 6 months. When switching back on, date and time are reset after a successful GPS fix.

Note: To achieve maximum lifetime of the Nyon battery pack, you should recharge it every 6 months if not using it.





Resetting Nyon

If, contrary to expectations, Nyon can no longer be operated, then Nyon can be reset by **simultaneously** pressing the buttons **1**, **2**, **5** and **6**. Carry out the reset only if absolutely necessary, as various configurations may be lost.

Battery Charge-control Indicator

The battery charge level indicator **r10 (s7)** displays the charge level of the eBike battery pack. The charge level of the Nyon battery pack can be read on the display **s1**. The charge level of the eBike battery pack can also be read on the LEDs on the eBike battery pack itself.

In the indicator **r10**, each large bar in the battery symbol corresponds to approximately 20 % capacity, while each thin bar corresponds to approximately 10 % capacity:

-  The eBike battery pack is fully charged.
-  The eBike battery pack should be recharged.
-  The capacity for assisting the drive has been used up, and assistance is gently switched off. The remaining capacity will be provided for the bike light and the on-board computer. The capacity of the eBike battery pack is enough for about 2 hours of lighting. This does not account for other consumers (e.g. automatic gearbox, charging external devices at the USB port).
-  Nyon has never been inserted into the holder **4** or Nyon has been reset to the factory configurations.

If the on-board computer is removed from the holder **4**, the last displayed battery charge level is saved.

Setting the Assistance Level

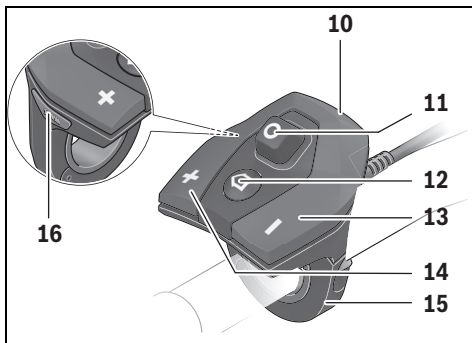

On the operating unit **10** you can set how much the eBike drive assists you while pedalling. The assistance level can be changed at any time, even while cycling.

Note: For individual versions, it is possible that the assistance level is pre-set and cannot be changed. It is also possible that less assistance levels are available for selection than listed here.

The following assistance levels (max.) are available:

- **“OFF”**: The motor assistance is switched off, and the eBike can be moved as a normal bicycle only by pedalling. The push assistance cannot be activated in this assistance level.
- **“ECO”**: Effective assistance at maximum efficiency for maximum cruising range
- **“TOUR”**: Uniform assistance, for touring with long cruising range
- **“SPORT”**: Powerful assistance for sportive riding off road as well as for urban traffic
- **“TURBO”**: Maximum assistance, supporting highest cadence for sportive riding

To **increase** the assistance level, press the “+” **14** button on the operating unit until the desired assistance level appears in the display **r5**. To **decrease** the assistance level, press the button “-” **13**.

The requested motor output is displayed in indicator **r4**. The maximum motor output depends on the selected assistance level.

Assistance Level	Assistance Factor* (Derailleur)			
	Active Line	Performance Line		
	Cruise	Cruise	Speed	CX
“ECO”	40 %	50 %	55 %	50 %
“TOUR”	100 %	120 %	120 %	120 %
“SPORT”	150 %	190 %	190 %	210 %
“TURBO”	250 %	275 %	275 %	300 %

* The motor output can vary for individual versions.

When the on-board computer is removed from the holder **4**, the last indicated assistance level is stored; the motor-output indicator **r4** remains empty.

Switching the Push-assistance mode On/Off

The push-assistance feature makes it easier to push the eBike. The speed in this function depends on the set gear and cannot exceed 6 km/h (max.). The lower the set gear, the lower the speed in the push-assistance function (at full output).

► **The push-assistance function may only be used when pushing the eBike.** Danger of injury when the wheels of the eBike do not have ground contact while using the push-assistance function.

To **activate** the push-assistance function, briefly press button **“WALK”** on your on-board computer. After activation, press button **“+”** within 3 s and keep it pressed. The eBike drive is switched on.

The push assistance is **switched off** as soon as one of the following occurs:

- You release button **“+” 14**,
- The wheels of the eBike are blocked (e.g. by actuating the brakes or impacting against an obstacle),
- The speed exceeds 6 km/h.

After releasing the **“+”** button, the push assistance remains on standby for another three seconds. Pressing the **“+”** button again within this period will reactivate the push assistance.

Note: On some systems the push-assistance function can be started directly by pressing the **“WALK”** button.

Note: The push assistance cannot be activated in the **“OFF”** assistance level.

Switching bike lights on/off

In the model, in which the lighting is powered by the eBike system, the front and rear light can be switched on and off at the same time via the on-board computer with the button **6**.

The illumination symbol **s1** is displayed when the light is on.

Switching the bike light on and off has no effect on the back lighting of the display.

eShift (optional)

eShift is the integration of automatic gear shifting systems into the eBike system. You can configure the settings for the “**eShift**” function under “**My eBike**”. The gear or the cadence is displayed in the “**Ride**”, “**Fitness**” and “**Map & Navigation**” operating modes. If the field is not displayed, the user is informed of changes by means of an indication on the display. eShift mode is activated by holding down the “**Home**” button **12**. It is only possible to activate eShift mode via the operating unit **10**. You can exit “**eShift**” mode again by repeatedly pressing the “**Home**” button.

eShift with NuVinci H|Sync

The optimum gear for the respective speed is automatically set according to a pre-defined desired cadence. In manual mode you can choose between multiple gears.

In the “**Cadence Control**” mode, you can use the “**-**” or “**+**” button on the operating unit to increase or decrease the required cadence. If you hold down the “**-**” or “**+**” button, the cadence will increase or decrease in increments of five. The desired cadence is shown on the display.

In the “**Gear Control**” mode, you can use the “**-**” or “**+**” button on the operating unit to switch back and forth between several defined transmission ratios. The engaged gear is shown on the display.

Under “**Gear calibration**”, you can calibrate the continuously variable transmission. Then follow the instructions on the display.

In the event of an error, it can also be necessary to perform calibration when riding. Confirm the calibration here too, and follow the instructions on the display.

eShift with SRAM DD3 Pulse

The hub gear of the SRAM DD3 Pulse works on a speed-dependent basis. Regardless of which gear is engaged on the derailleur gears, one of the three gears of the gear hub will automatically be engaged.

It is also possible to use the “-” or “+” button to shift gear manually here. Automatic mode is activated automatically if you press the “-” button in first gear. If you press the “-” or “+” button in automatic mode, the mode changes back to manual mode. In automatic mode, only “A” is ever shown in the gear display. If the gear is shifted in automatic mode, the gear is **not** shown on the display.

If you are not in automatic mode, the engaged gear will be shown briefly on the display whenever the gear of the hub gear is shifted.

The drive unit recognises the gear shift and briefly reduces the motor assistance level as a result of it, which means the gear can also be shifted at any time under load or on a hill.

If the eBike is brought to a stop from a speed of more than 10 km/h, the system may automatically shift down a gear to a set “**Starting gear**”. The “**Starting gear**” can be set under “**My eBike**” > “**eShift (SRAM)**”.

eShift with Shimano Di2

For Shimano eShift you use the Shimano control lever to shift gears.

The gear is always displayed in the eShift field. The gear is displayed briefly during a gear shift only when the eShift field is not visible (e.g. in settings).

The drive unit recognises the gear shift and briefly reduces the motor assistance level as a result of it, which means the gear can also be shifted at any time under load or on a hill.

If the eBike is brought to a stop from a speed of more than 10 km/h, the system may automatically shift down a gear to a set “**Starting gear**”. The “**Starting gear**” can be set under “**My eBike**” > “**eShift (Shimano)**”.

Displays and settings of the smartphone application “Bosch eBike Connect”

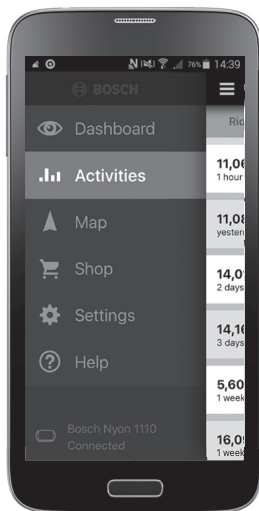

A smartphone is not included in the delivery. To register with the smartphone internet connection is required, which, depending on the contract, can generate costs at your telephone provider. For the synchronization of data between the smartphone and online portal an Internet connection is also required.

Activating the application “Bosch eBike Connect”

In order to be able to use all features of your Nyon, it is necessary to have a smartphone with the “**Bosch eBike Connect**” application.

Proceed as follows to perform activation:

- Open Google Play (Android) or the App Store (iOS) on your smartphone.
- Search for “**Bosch eBike Connect**”.
- Install the “**Bosch eBike Connect**” application and open it.
- Register as described in the next section.







If you have already registered via the online portal, you can also log in directly with your login data. The “**Bosch eBike Connect**” application will then search for an available Nyon on-board computer. If necessary, insert your Nyon into the holder and follow the instructions to establish the Bluetooth® connection.

Registration via smartphone and Bluetooth® connection

- Start the “**Bosch eBike Connect**” application.
- Select “**REGISTER**”.
- Read and accept the terms and conditions and the privacy policy.
- Switch the on-board computer on using the On/Off button **5** to set up the Bluetooth® connection.
- Select “**SEARCH**” on your smartphone. The application will try to find your on-board computer and will display it once the search has been successful. If your on-board computer is not found, ensure that Bluetooth® is activated on your on-board computer. You can view this setting under “**Settings**” > “**Connections**” > “**Bluetooth = On**”.
- Perform the Bluetooth® link by checking and confirming the code displayed on your on-board computer.
- Once the link has been successfully established, press “**NEXT**” and start collection of your personal data.
- Follow the instructions and complete the registration. According to the answers you give about your fitness level, you will be assigned to a fitness category which is required for the “**Fitness**” operating mode.

If the application “**Bosch eBike Connect**” is active and there is a Bluetooth® connection to your on-board computer, data between on-board computer and smartphone will sync automatically.

Main menu of “Bosch eBike Connect”

Symbol	Menu item	Function
	“Dashboard”	This operating mode displays various pieces of statistical data, the connection status and the synchronisation status.
	“Activities”	Under this menu item you can view the trips you have made.
	“Map”	You can use this menu item to plan routes and view the remaining range of your eBike.
	“Shop”	You can use this menu item to download additional map material or purchase premium features.
	“Settings”	You can use this menu item to create custom screens (“ Custom Screens ”) and custom riding modes (“ Custom Modes ”) and manage your profile.
	“Help”	Under this menu item you will find the FAQ, contact details and other information.

Menu item “Dashboard”

Under this menu item, the current location of the bicycle on a map, the synchronisation status and the kilometres travelled in the last 30 days are displayed.

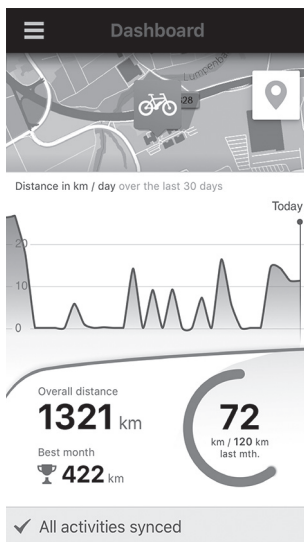

Menu item “Activities”

Three views of your trips are available under this menu item.

- **“Rides”**: Each of the trips is displayed here (from switching on the on-board computer to the next time it was switched off).
A **“Ride”** is complete:
 - When Nyon is shut down.
 - When Nyon is removed from the holder.
 - When a manual or automatic reset is performed.
- **“Days”**: All the trips started on one day are summarised here.
- **“Trips”**: All trips are displayed here, starting with the first trip until the counter is either reset manually or automatically.

When you select a journey, you will be shown the trip distance, the trip duration, the average speed, and also the route travelled on a map. The elevation profile of your eBike journey will also be displayed.

Unsynchronised activities are displayed with this symbol .

Activities which are not complete are also displayed following synchronisation.

Menu item “Map”

When you have selected this menu item, your current location will be shown using the GPS function of the smartphone. You can use the signpost symbol in the top right corner to start route planning.

- You can use the “**Enter destination address**” menu item to enter the destination address. Once you have entered the destination, you will be offered three different routes (“**Short/MTB**”, “**Scenic**” and “**Fast**”) displaying the elevation profile.
- The “**Short**” route shows you the shortest way from your location to your selected destination (**only** for eBikes up to 45 km/h).
- The “**MTB**” route guides the cyclist over mostly unpaved trails and offers the best route for mountain bikers (**not** for eBikes up to 45 km/h).
- The “**Scenic**” route shows you the most scenic connection from your location to your selected destination and avoids main roads.
- The “**Fast**” route shows you the fastest connection from your location to your selected destination while avoiding steeper slopes.
The different “**Short/MTB**”, “**Scenic**” and “**Fast**” routes may be identical on short routes.
- Once you have selected your preferred route, you can transfer the route to your Nyon by pressing the button at the top right. There you can start navigation or just save the route for later.
- You can also postpone the start and end point using “Tap and Drop” later.
- You can add another intermediate destination by tapping on another location.

In addition to route planning, you will find your previously saved destinations and routes. Starting from your current location, you can also navigate home or to work.

Menu item “Shop”

Use the premium features in the “**Shop**” menu item to extend the features on your Nyon.

- “**Custom Modes**” (Custom Riding Modes): Four different riding modes can be configured with this expansion. This means that for each of the four riding modes, you can set the level of motor assistance at three points based on the speed.
- “**Topo operating range**”: This expansion enables details of the battery’s remaining range to be displayed, taking into consideration the geographical conditions.

Menu item “Settings”

You can use the “**Settings**” menu item to make extensive settings for and changes to the personal profile, the eBike and the Nyon.

- “**My Profile**”: The personal data collected by registration are contained here. These data can be adjusted, expanded and corrected here. If a Bluetooth® link or Nyon wi-fi link to the web exists, these data are automatically synchronised.
Here you can also set up and edit your home address and your work address, set up your “**Bosch eBike Connect**” login via Facebook and change your password.
- “**My Nyon**”: An existing Bluetooth® connection to Nyon is required to display this section. The section shows information about the on-board computer, synchronisation can be performed, the current Nyon can be deleted and another Nyon can be connected to.
- “**My eBike**”: This displays the eBikes connected to Nyon. If Nyon was placed on at least two different eBikes, they are displayed here for selection. Otherwise no selection is possible and only one eBike is displayed. You can edit the name for each eBike. You can also create and edit your custom views and your personal riding modes. You can also delete any eBike.
“**Custom Screens**”: You can create a custom view for each of the operating modes “**Ride**” and “**Fitness**”.

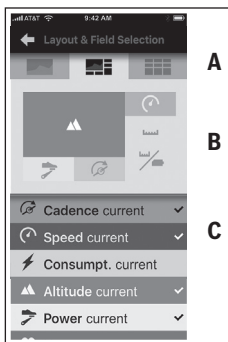

You can choose from three layouts for the custom views in the upper section (A) and you can select the data you want to have displayed in both sections. This is done by selecting the corresponding field in the middle section (B) and then selecting the desired values or graphs from the list in the lower section (C). Save the view to complete the procedure. If there is an existing Bluetooth® connection, the view will then be automatically transferred to the Nyon.

“Custom Modes”: This setting option is available only if you have purchased it via the shop.

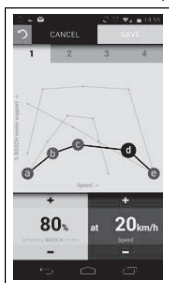

You can configure four different riding modes however you like. For the configuration there are five definable “checkpoints” or stages available. For the middle three points you can select any desired performance assistance for a certain speed. For the outer two points you can only select the performance assistance. The speed is plotted on the horizontal x-axis and the performance assistance on the vertical y-axis in percent. If you are happy with the definition, save the riding mode. If there is an existing Bluetooth® connection, the riding mode will then be automatically transferred to the Nyon.

- **“Map Manager”:** Use the **“Map Manager”** to load any map directly to Nyon.

Transferring the maps to Nyon

Nyon only has the maps currently required for navigation in its cache memory **21** and automatically loads the areas required for navigation as required.

If Nyon realises that it needs additional map material, it initially either searches for map material available locally in the main memory **22** of the Nyon or it searches for map material in the smartphone memory **23**. If the required maps are not available, Nyon connects to the internet via the smartphone and automatically downloads the required map material from the internet into its cache memory **21**.

Caution! Roaming fees may be charged if you ride your eBike abroad. For this reason, load the required maps onto your smartphone or your Nyon before embarking on your journey abroad.

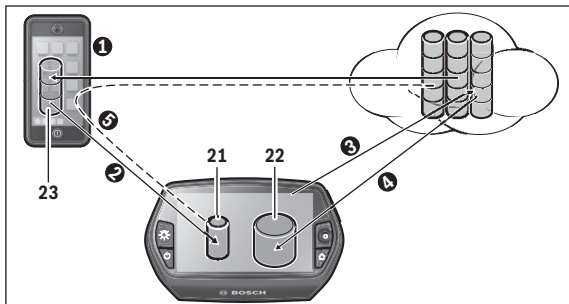

The maps are transferred to the Nyon cache memory as follows:

– **Downloading the maps to the smartphone and transferring them to Nyon:**

On your smartphone, select the **“Map Manager”** menu item in the **“Settings”** menu and load the desired maps onto your smartphone (❶). If Nyon requires maps, the data will load automatically via Bluetooth® from your local smartphone memory **23** directly into the Nyon cache memory (❷). The map is then available for navigation.

– **Downloading the maps to Nyon:**

This function is available only when Nyon is connected to a WLAN network. For this reason, connect to a WLAN network (❸) in order to have access to the internet.

Select the **“Map Manager”** menu item under **“Settings” > “Map & Navigation”** on your Nyon. Select the desired maps and download them (❹). If required, the Nyon will transfer the saved maps from its main memory **22** to its cache memory **21**. The map is then available for navigation.

– **Transferring the maps from the internet via a smartphone:**

If Nyon requires maps and they are not located in the local memory **21/22** or in the smartphone memory **23**, Nyon will automatically establish an internet connection via the smartphone (❺) and load the required data into its cache memory **21**. The map is then available for navigation.

Menu item “Help”

In the **“Help”** menu item, you will find a selection of FAQs (frequently asked questions), contact details and information about the system and licenses.

Displays and settings of the online portal







Online registration

Internet access is required for online registration.

- Use your browser to open the **“Bosch eBike Connect”** online portal at **“www.eBike-Connect.com”**.
- Read and accept the terms and conditions and the privacy policy.
- Follow the instructions and complete the registration. According to the answers you give about the typical frequency and duration of your sporting activities, you will be assigned to an activity level which is required for the **“Fitness”** operating mode.

When you have registered, from this point on you can log in with your e-mail address and password or via **“Facebook login”**. The login data of the online portal matches the login data of the **“Bosch eBike Connect”** smartphone application. An existing Facebook profile is essential for **“Facebook login”**.

Online portal main menu

Symbol	Menu item	Function
	“Dashboard”	Statistical data are shown under this menu item.
	“Activities”	Under this menu item you can view the trips you have made.
	“Map”	You can plan routes via this menu item.
	“Settings”	You can use this menu item to create custom views and manage your profile.

Menu item “Dashboard”

This operating mode shows you the savings **d4** you can make if you ride the bike instead of driving a car.

Basis for the calculation is the average **energy cost** of fuel and electricity.

Menu item “Activities”

Three views of your trips are available under this menu item.

- **“Rides”**: Each of the trips is displayed here (from switching on the on-board computer to the next time it was switched off).
A **“Ride”** is complete:
 - When Nyon is shut down.
 - When Nyon is removed from the holder.
 - When a manual or automatic reset is performed.
- **“Days”**: All the trips started on one day are summarised here.
- **“Trips”**: All trips are displayed here, starting with the first trip until the counter is either reset manually or automatically.

When you select a journey, you will be shown the trip distance, the trip duration, the average speed, and also the route travelled on a map. The elevation profile of your eBike journey will also be displayed.

If you use a chest strap, your heart rate is also displayed.

Activities which are not complete are also displayed following synchronisation.

Menu item “Map”

You can also perform your route planning in the online portal.

- You can use the **“Plan a route”** menu item to enter a destination address. Once you have entered the destination, you will be offered three different routes (**“Short/MTB”**, **“Scenic”** and **“Fast”**) displaying the elevation profile.
- The **“Short”** route shows you the shortest way from your location to your selected destination (**only** for eBikes up to 45 km/h).
- The **“MTB”** route guides the cyclist over mostly unpaved trails and offers the best route for mountain bikers (**not** for eBikes up to 45 km/h).
- The **“Scenic”** route shows you the most scenic connection from your location to your selected destination and avoids main roads.
- The **“Fast”** route shows you the fastest connection from your location to your selected destination while avoiding steeper slopes.
The different **“Short/MTB”**, **“Scenic”** and **“Fast”** routes may be identical on short routes.
- Once you have selected your preferred route, you can transfer the route to your Nyon by pressing the button at the top right. There you can start navigation or just save the route for later.
- You can also postpone the start and end point using “Drag and Drop” later.
- You can add another intermediate destination by right-clicking another location on the map.

In addition to route planning, you will find your previously saved destinations and routes.

Import GPX data

GPX data contain a number of geographical coordinates (waypoints) whose sequence describe a route. The GPX data can be used for navigation with Nyon. You can create or edit GPX data with the appropriate programs.

You can import GPX data over the online portal and save files up to 5 MB in size there (GPX 1.1 format). GPX data are transferred to Nyon as soon as Nyon is connected via the smartphone to the web over wi-fi or Bluetooth®. On its own, Nyon cannot import GPX data directly over a USB link.

The routability of GPX tracks depends on the accuracy of details on OSM maps. The following results are possible depending on the existence of roads and tracks which are navigable:

- **GPX Track can be fully routed**

As usual, navigation is possible, including turn-off instructions and information of the remaining distance and estimated time of arrival. If Nyon is close to the starting point, navigation can be started immediately.

If Nyon is further away from the starting point, the rider can be navigated to that point.

- **GPX Track cannot be routed**

The route is displayed statically on Nyon and can be travelled by the rider. No navigation details or time calculations can be made.

- **GPX Track can be partially routed**

If you use the changed versions, you can convert and save the route into a fully routable track.

If you have the original version, the route is treated as a non-routable track.

Menu item “Settings”

Under “Settings” you can adjust your profile, request a new password, adjust your fitness status, change the registered address and the work address. You can create and adapt custom views and custom riding modes.

Device Information

Technical Data

On-board computer		Nyon
Article number		1 270 020 907/915
Internal memory in total		
1 270 020 907	GB	1
1 270 020 915	GB	8
Max. charging current, USB connection	mA	500
Charging voltage, USB connection	V	5
USB charging cable ¹⁾		1 270 016 360
Operating temperature	°C	-5...+40
Storage temperature	°C	-10...+50
Charging temperature	°C	0...+40
Protection type ²⁾		IP x7 (watertight)
Supported wi-fi standards		802.11b/g/n (2.4 GHz)
Weight, approx.	kg	0.2

1) Not included as part of standard delivery
2) When USB cover is closed

Error Code Indication

The components of the eBike system are continuously and automatically monitored. If an error is detected, the respective error code is indicated on the on-board computer.

Depending on the type of error, the drive unit is automatically shut off, if required. Continued travel without assistance from the drive unit is possible at any time. However, have the eBike checked before attempting new trips.

► **Have all repairs performed only by an authorised bike dealer.**

Code	Cause	Corrective Measure
410	One or more buttons of the on-board computer are blocked.	Check if any buttons are blocked, e.g. from dirt or debris. Clean the buttons, if required.
414	Connection problem of the operating unit	Have connections and contacts checked.. Contact your Bosch eBike dealer.
418	One or more buttons of the operating unit are blocked.	Check if any buttons are blocked, e.g. from dirt or debris. Clean the buttons, if required.
422	Connection problem of the drive unit	Have connections and contacts checked.
423	Connection problem of the eBike battery pack	Have connections and contacts checked.
424	Communication error among the components	Have connections and contacts checked.
426	Internal time-out error	Restart the system. If the problem persists, contact your Bosch eBike dealer.
430	Internal battery pack of the on-board computer is empty.	Charge the on-board computer (in the holder or via the USB port).
431	Software version error	Restart the system. If the problem persists, contact your Bosch eBike dealer.
440	Internal error of the drive unit	Restart the system. If the problem persists, contact your Bosch eBike dealer.

Code	Cause	Corrective Measure
450	Internal software error	Restart the system. If the problem persists, contact your Bosch eBike dealer.
460	Error at USB connection	Remove the cable from the USB connection of the on-board computer. If the problem persists, contact your Bosch eBike dealer.
490	Internal error of the on-board computer	Have the on-board computer checked.
500	Internal error of the drive unit	Restart the system. If the problem persists, contact your Bosch eBike dealer.
502	Bike lighting error	Check the light and the associated wiring. Restart the system. If the problem persists, contact your Bosch eBike dealer.
503	Error of the speed sensor	Restart the system. If the problem persists, contact your Bosch eBike dealer.
510	Internal sensor error	Restart the system. If the problem persists, contact your Bosch eBike dealer.
511	Internal error of the drive unit	Restart the system. If the problem persists, contact your Bosch eBike dealer.
530	Battery pack error	Switch off the eBike, remove the eBike battery pack and reinsert the eBike battery pack. Restart the system. If the problem persists, contact your Bosch eBike dealer.
531	Configuration error	Restart the system. If the problem persists, contact your Bosch eBike dealer.
540	Temperature error	The eBike is outside of the permissible temperature range. Switch off the eBike system and allow the drive unit to either cool down or heat up to the permissible temperature. Restart the system. If the problem persists, contact your Bosch eBike dealer.

Code	Cause	Corrective Measure
550	An improper load was detected.	Remove load. Restart the system. If the problem persists, contact your Bosch eBike dealer.
580	Software version error	Restart the system. If the problem persists, contact your Bosch eBike dealer.
591	Authentication error	Switch off the eBike system. Remove the battery pack and reinsert it. Restart the system. If the problem persists, contact your Bosch eBike dealer.
592	Incompatible component	Insert a compatible display. If the problem persists, contact your Bosch eBike dealer.
593	Configuration error	Restart the system. If the problem persists, contact your Bosch eBike dealer.
595, 596	Communication error	Check the wiring to the transmission and restart the system. If the problem persists, contact your Bosch eBike dealer.
602	Internal battery pack error while charging	Unplug the charger from the battery pack. Restart the eBike system. Plug the charger into the battery pack. If the problem persists, contact your Bosch eBike dealer.
602	Internal battery pack error	Restart the system. If the problem persists, contact your Bosch eBike dealer.
603	Internal battery pack error	Restart the system. If the problem persists, contact your Bosch eBike dealer.

Code	Cause	Corrective Measure
605	Battery pack temperature error	The eBike is outside of the permissible temperature range. Switch off the eBike system and allow the drive unit to either cool down or heat up to the permissible temperature. Restart the system. If the problem persists, contact your Bosch eBike dealer.
605	Battery pack temperature error while charging	Unplug the charger from the battery pack. Allow the battery pack to cool. If the problem persists, contact your Bosch eBike dealer.
606	External battery pack error	Check the wiring. Restart the system. If the problem persists, contact your Bosch eBike dealer.
610	Battery pack voltage error	Restart the system. If the problem persists, contact your Bosch eBike dealer.
620	Charging error	Replace the charger. Contact your Bosch eBike dealer.
640	Internal battery pack error	Restart the system. If the problem persists, contact your Bosch eBike dealer.
655	Multiple battery pack errors	Switch off the eBike system. Remove the battery pack and reinsert it. Restart the system. If the problem persists, contact your Bosch eBike dealer.
656	Software version error	Contact your Bosch eBike dealer so that he can perform a software update.
No display	Internal error of the on-board computer	Restart your eBike system by switching it off and back on.

Maintenance and Cleaning

Please observe the operating and storage temperatures of the eBike components. Protect the drive unit, on-board computer and battery against extreme temperatures (e.g. from intense sunlight without adequate ventilation). The components (especially the battery pack) can become damaged through extreme temperatures.

An abrupt change of environmental conditions, can cause the screen to fog up from inside. After a short time, a temperature adjustment takes place and the fog disappears.

Keep the screen of your Nyon clean. Dirt can cause faulty brightness detection. The day/night switch-over in the navigation mode can be distorted.

Keep all components of your eBike clean, especially the battery-pack contacts and corresponding holder contacts. Clean them carefully with a soft, damp cloth.

Have your eBike checked by an expert at regular intervals. The on-board computer displays a message telling you when the service date is due for four seconds after switching it on. The bicycle manufacturer or dealer may base the service date on the distance travelled and/or on a period of time.

Do not immerse any components, including the drive unit, in water or clean them with pressurised water.

Clean your on-board computer using a soft cloth dampened only with water. Do not use any detergents.

Have your eBike system checked by an expert at least once a year (including mechanical parts, up-to-dateness of system software).

The bicycle manufacturer or dealer may also base the service date on the distance travelled and/or a period of time. In this case, the on-board computer displays a message telling you when the service date is due for four seconds after each time it is switched on.

For service or repairs on the eBike, please refer to an authorised bicycle dealer.

► **Have all repairs performed only by an authorised bike dealer.**

After-sales Service and Application Service

In case of questions concerning the eBike system and its components, please refer to an authorised Bosch eBike dealer.

For contact data of authorised Bosch eBike dealers, please refer to **www.bosch-ebike.com**

Transport

- ▶ **If you transport your eBike attached to the outside of your car, e.g. on a bike rack, remove the on-board computer and the PowerPack to avoid damaging them.**

The battery packs are subject to the Dangerous Goods Legislation requirements. Private users can transport undamaged battery packs by road without further requirements.

When being transported by commercial users or third parties (e.g. air transport or forwarding agency), special requirements on packaging and labelling must be observed (e.g. ADR regulations). If necessary, an expert for hazardous materials can be consulted when preparing the item for shipping.

Dispatch battery packs only when the housing is undamaged. Tape or mask off open contacts and pack up the battery pack in such a manner that it cannot move around in the packaging. Inform your parcel service that the package contains dangerous goods. Please also observe the possibility of more detailed national regulations.

In case of questions concerning transport of the battery packs, please refer to an authorised Bosch eBike dealer. The Bosch eBike dealers can also provide suitable transport packaging.

Disposal



The drive unit, on-board computer including operating unit, battery pack, speed sensor, accessories and packaging should be disposed of in an environmentally correct manner.

Do not dispose of eBikes and their components into household waste!

Only for EC countries:



According to the European Guideline 2012/19/EU, electrical devices/tools that are no longer usable, and according to the European Guideline 2006/66/EC, defective or used battery packs/batteries, must be collected separately and disposed of in an environmentally correct manner.

The integrated battery pack in the on-board computer may only be removed for disposal. Opening the housing shell can destroy the on-board computer.

Please return battery packs and on-board computers that are no longer usable to an authorised bicycle dealer.

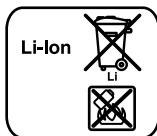

Li-ion:

Please observe the instructions in section “Transport”, page English – 61.

Subject to change without notice.

Robert Bosch GmbH
Bosch eBike Systems
72703 Reutlingen
GERMANY

www.bosch-ebike.com

1 270 020 Wen (2016.05) T / 63